

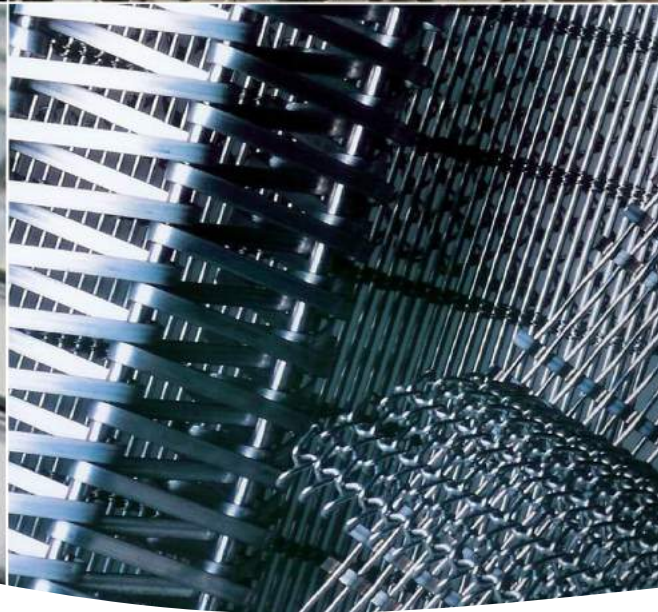

**METAL MESH**

Woven & Welded Wire Mesh, Perforated Metal, Extruder Discs

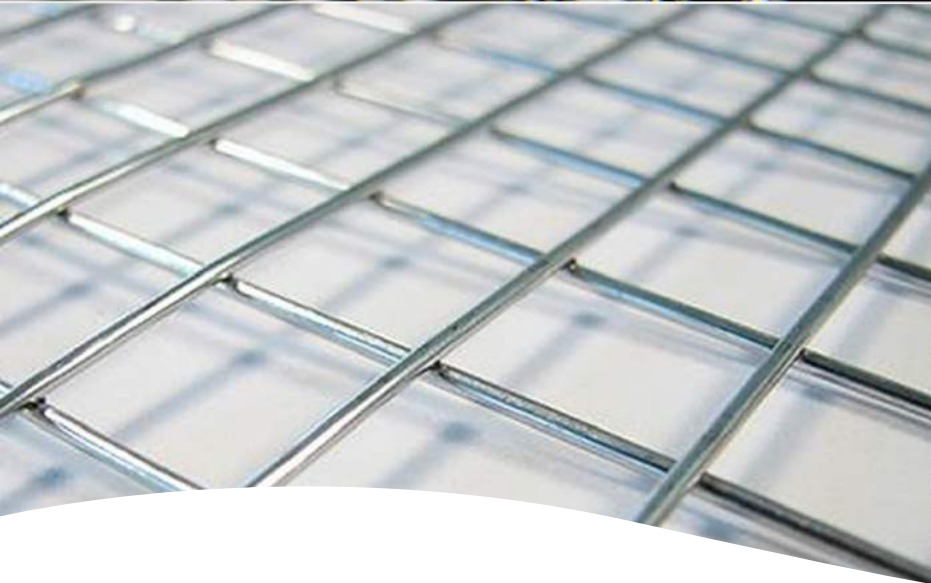
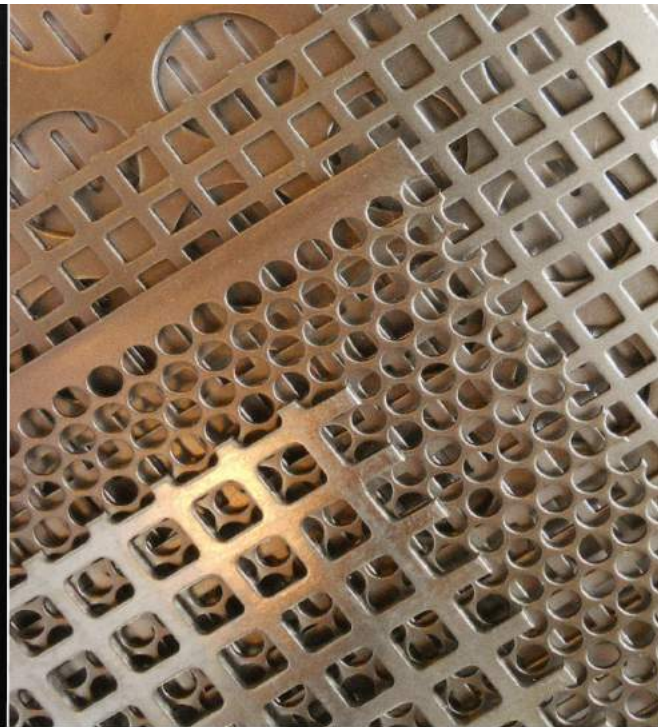
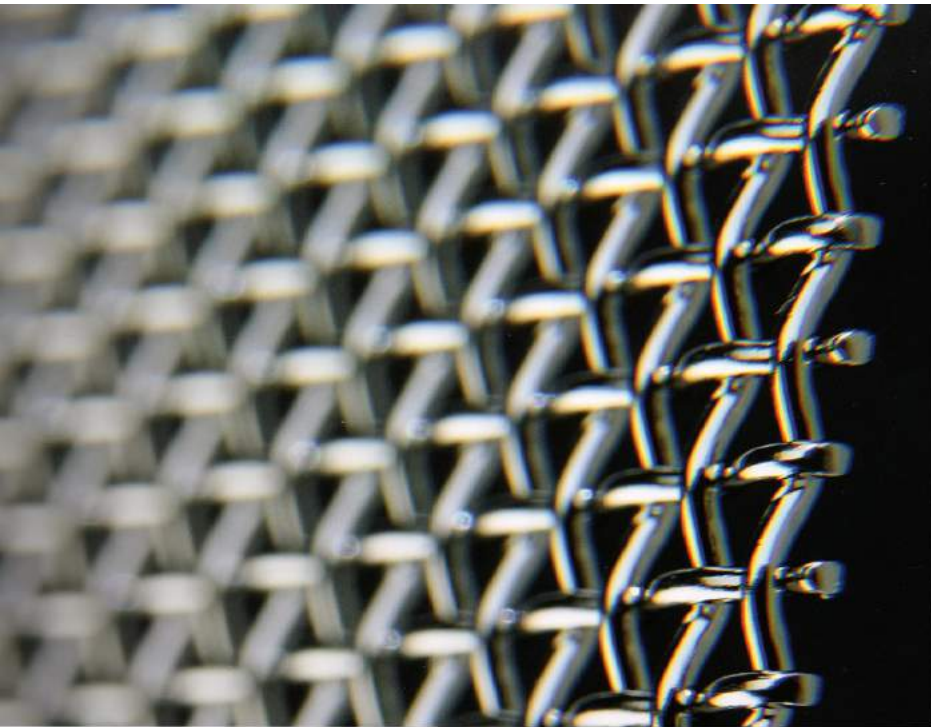

**S E F A R**  
■ ■ ■ ■

## Contents

---

Introduction	2
<u>Quality:</u>	
- Test Certificates	3
<u>Woven Wire Mesh:</u>	4
- Selection criteria	5
- Stainless Steel grades	8
- Stainless Steel care	9
- Market Grade Stainless Steel Square Mesh	10
- Bushfire Mesh	15
- Bolting Cloth	16
- FDA Compliant Food Grade Bolting Cloth	18
- Hollander Weave	20
<u>Extruder discs:</u>	
- Single Screen Discs	21
- Screen Packs	
- Rim Discs	
- Rectangular/Oblong Mesh	22
<u>Welded Wire Mesh:</u>	
- Rolls	23
- Sheets	24
Brass Woven Wire Mesh	25
<u>Perforated Metals:</u>	26
- Selection Criteria	27
- Round Holes	28
- Square Holes	37
- Round End Slots / Processing Screens	39
<u>Contact details</u>	40

## Introduction

---

### About Metal Mesh

Metal Mesh is what we know best. We've been supplying and fabricating since 1970. Access to local industry developments and the latest in European technology means we're always looking at improving our products and expanding our range to meet your needs. We are Quality Endorsed to ISO 9001 standards so you're always guaranteed high levels of quality control and service.

Choose from our premium range of woven mesh, welded mesh and perforated metal in rolls or sheets, and we can custom fabricate discs, cylinders, screens and sieves to your specifications.

Market Grade Stainless Steel Woven Wire Mesh, Stainless Steel Bolting Cloth, Stainless Steel Hollander Weave Mesh, Stainless Steel Welded mesh are all held in stock.

Select from over two hundred and fifty types of perforated metal held in stock, in standard sheets up to 3mm in thickness, from hole sizes 0.5mm to 20mm. Mild Steel, Galvanised Steel, Stainless Steel Type 304 & 316 and Aluminium, are all standard lines. Cut pieces and custom fabricated products are also available.

In addition we can offer custom perforated metal to your specifications.

### About Sefar

For over 180 years Sefar has been a leading problem solver for process industry applications worldwide. We offer the broadest selection of filtration and separation products, backed by an experienced team of application specialists.

From Milling, Food, Beverage and Environmental Technologies to Chemicals, Pharmaceuticals, Life Science, Mining and Refining our innovative products have been proven in thousands of installations worldwide.

A collaboration of field sales and production personnel support our products and can assist you in providing the proper solution. This includes choosing the exact product type and performance to best meet your requirements.

Trust Sefar Metal Mesh as your trusted source for filtration and screening products. We are ready to meet your needs.

For expert advice on more technical aspects of mesh and perforated applications, simply call our customer service. With branch offices across Australia and New Zealand there is a location near you.

# Metal Mesh Quality

## Quality checks - Material Identification - Material Certification

### Overview

- Nondestructive alloy analysis to rapidly and accurately identify alloy grades and measure metal composition
- PMI inspections and QA / QC testing
- Product verification
- Highly specific material chemistry

### Quality Control

As part of our quest to provide you only with high grade, top quality products, we conduct material tests on all incoming goods using a portable X-ray machine for Positive Material Identification (PMI).

This ensures that all materials meet or exceed the quality standard and requirements.

### Material Identification

We are able to provide to you another service offering a reliable analysis of various materials to provide fast and accurate Positive Material Identification (PMI).

Not only are we able to analyse products we supply, but also items you would like to have identified, such as turnings, shavings, rods, and wires to small parts and components, to more sizeable material or structures.

### Material Certificates

Upon request, and subject to a nominal charge, we can now provide to you a Material Certificate relevant to the individual products you order from us, giving you the assurance that our products meet or exceed industry standards.

Please contact our customer service team for more information on this service, or ask for one of our product specialists to visit you to discuss your individual requirements!



### Metals and Alloys

Aluminium Alloys	Precious Metals
Chromium-Molybdenum Steels	Stainless Steels
Cobalt Alloys	Tool Steels
Copper Alloys	Titanium Alloys
Exotic Alloys	Wrought Alu Alloys
Magnesium Alloys	Zinc Alloys
Nickel Alloys	Zirconium Alloys
Nickel/Cobalt alloys	+ many more

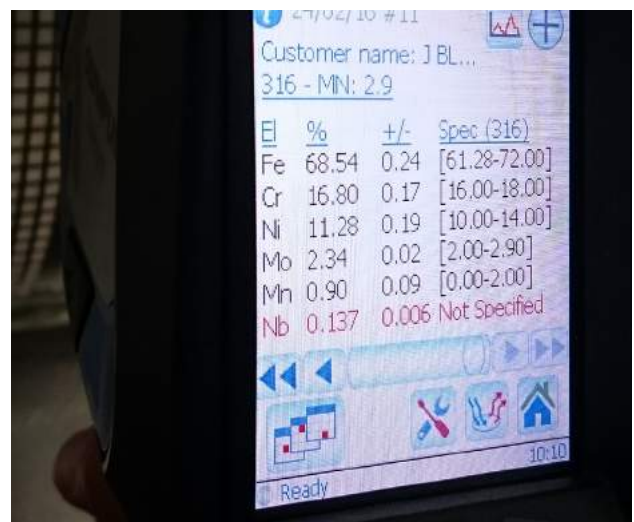

# Metal Mesh - Woven Wire Mesh / Welded Mesh Product Range



# Metal Mesh

## Choosing the right Woven Wire mesh

### Choosing the right Woven Wire Mesh

There are several factors involved in choosing the right mesh:

- Aperture Size
- Wire Diameter
- Materials
- Roll Length
- International Standards



#### Aperture Size

This determines the size of the particles to be eliminated. We offer as standard meshes from 35mm to 25 microns (0.025mm) compliant with ISO standard 4783. Where screening requires very tight tolerances, the manufacturing tolerances of the mesh must also be taken into consideration.

#### Wire Diameter

Selecting the wire diameter involves a number of different considerations.

The thicker the wire, the stronger and more robust the mesh and the longer the service life.

On the other hand, a thicker wire will reduce the open area and therefore reduce screening or sifting performance.

Reducing the wire diameter, whilst maintaining the same aperture size, increases the number of apertures within a defined surface area. Both performance and efficiency will increase.

Parameter	Thinner Wire	Thicker Wire
Screening Efficiency	↑	↓
Flow	↑	↓
Open Area	↑	↓
Number of apertures	↑	↓
Abrasion resistance	↓	↑
Strength	↓	↑
Weight	↓	↑

#### Materials

The most popular material is stainless steel to DIN 1.4301 (AISI 304) or DIN 1.4401 (AISI 316); selected specifications are also available in chrome steel to DIN 1.4016 (AISI 430).

#### Mesh Dimensions

Standard widths are 1245mm or 1580mm, but depending on the weaving equipment used slight variances are common. Standard roll length is 30m, individual pieces cut to size are available.

#### Mesh Selection

The mesh selection, particularly with fine meshes, depends on many process details and often can only be selected by carrying out trials.

The open area is influenced directly or indirectly by the service life of the screen, this is illustrated in the following table.

Open Area	Mesh Type	Apertures
> 60%	extra light	0.56 - 16
48 - 60%	light	0.212 - 5
36 - 48%	standard	0.038 - 2
< 36%	heavy	0.020 - 0.600

# Metal Mesh

## Choosing the right Weave or Mesh Type

### Choosing the right Weave or Mesh Type

The following type of weave are available

- Plain Weave / Square Mesh
- Rectangular Mesh
- Plain Dutch Weave
- Dutch Twilled Weave
- Crimped Screen

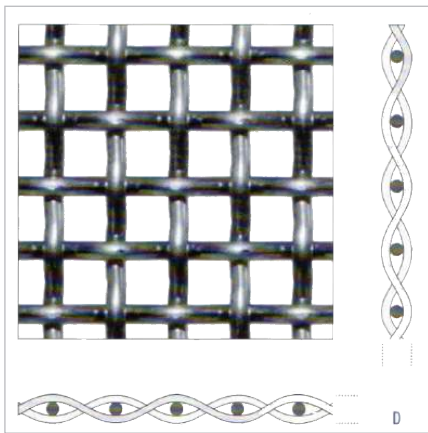

**Plain Weave / Square Mesh**  
The Plain Weave/Square Mesh is characterised by extremely exact mesh sizes. Weft wires are wound over and under the warp wires alternately in a constant pattern. The characteristics of this weave can be modified for special requirements.

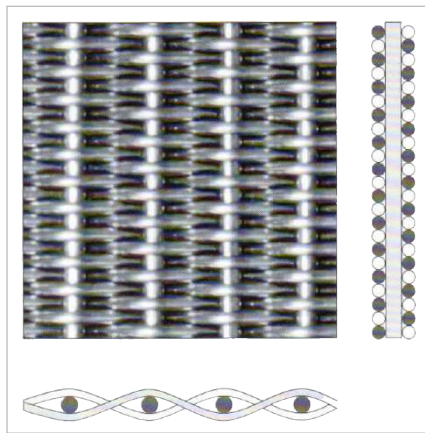

**Plain Dutch Weave**  
The warp wires in this weave type are always stronger than the weft wires. The so-called "Zero-Mesh" is created by positioning the weft wires as closely as possible together. The specific benefits are good flow rate and even openings.

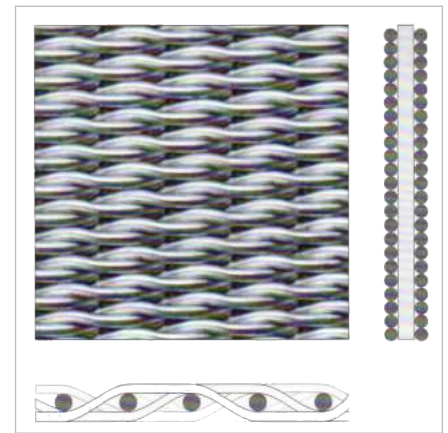

**Dutch Twilled Weave**  
This process involves forcing the weft wires together during weaving. This kind of mesh has double the number of weft wires compared with the plain Dutch weave, providing a particularly smooth surface for ultra fine filtration applications.

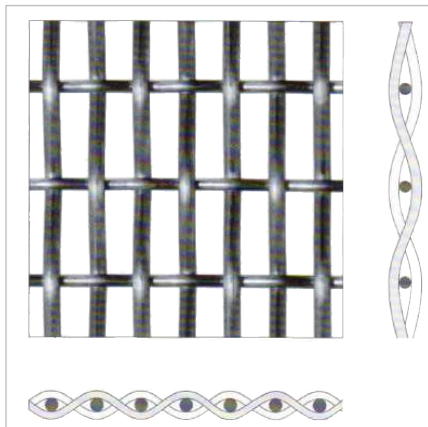

**Rectangular Mesh**  
Also called oblong/broad. The most common mesh ratio is 1:3. If the numbers are reversed the mesh is known as broad mesh. This mesh is used for vibrating sieving screens or other architectural applications.

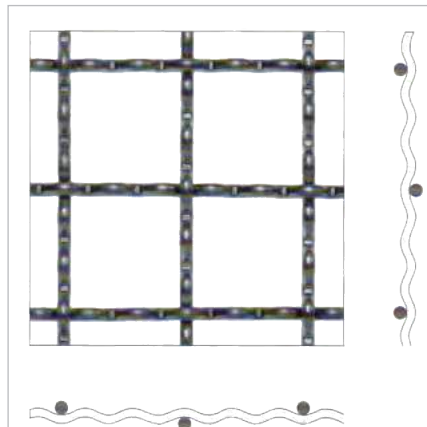

**Crimped Screen**  
Crimped Wires are used in both directions and combined to create a robust wire screen with a stable form and surface. Suitable as protective screens for fences, gates and partitions for rack shelving systems.

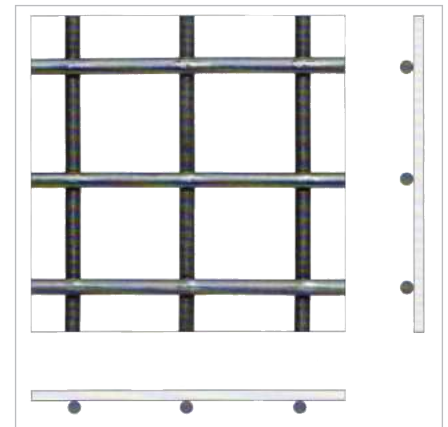

**Welded Mesh / Welded Screen**  
Similar to reinforced meshes, the horizontal wires (roll width) are secured to the vertical wires (roll length) by spot welding. These constant connection points give the screen a high level of stability.

# Metal Mesh Terminology / Glossary

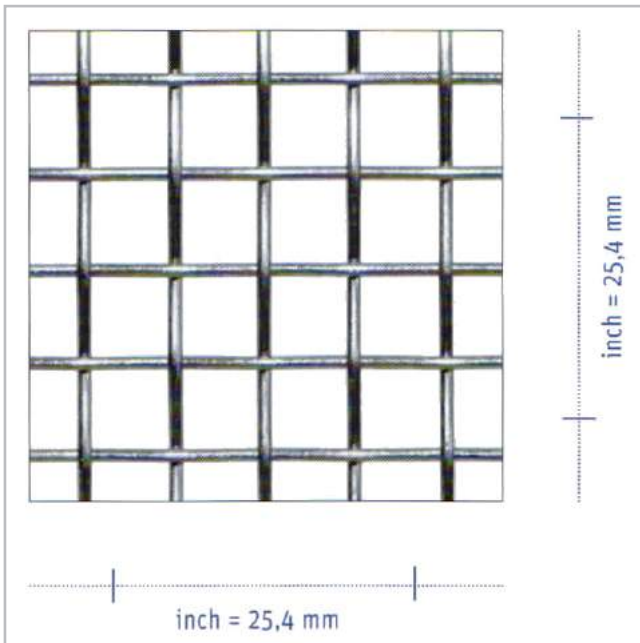

**Mesh Count**  
The Mesh count refers to the number of wires & apertures per inch. This is determined by aperture size (a) and wire diameter (d).

$$\text{Mesh} = \frac{25.4\text{mm}}{a \text{ (mm)} + d \text{ (mm)}}$$

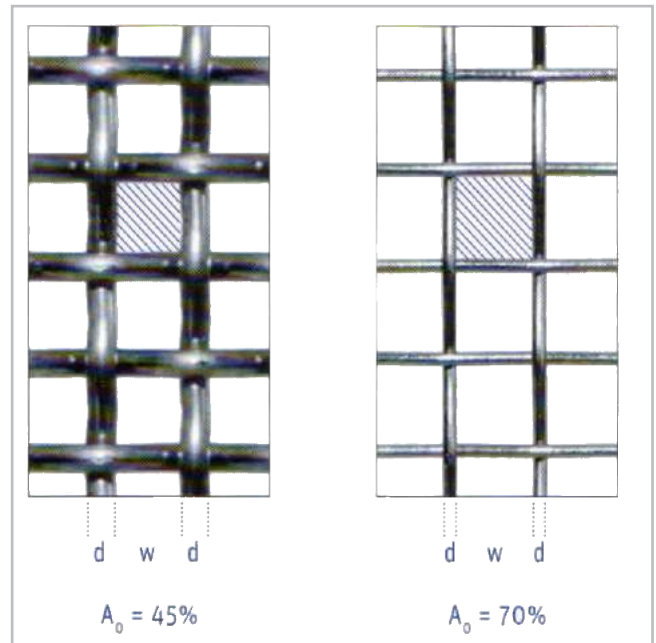

**Open Area**  
The open area of a screen (Ao) defines the mesh openings as a percentage of the entire screen surface and is based on the ratio between aperture size (w) and wire diameter (d).

$$A_o = \left( \frac{w \text{ (mm)}}{w \text{ (mm)} + d \text{ (mm)}} \right)^2 \times 100\%$$

Term	Description
Absolute Filter Rating	Filter rating at 99% efficiency
Nominal Filter Rating	Filter rating at 70-90% efficiency
Aperture	Distance between wire threads, measured in microns or millimeters
Pitch	Distance from centre to centre of wire threads
SWG	Standard Wire Gauge (Imperial Measurement)
Imperial Mesh	Number of apertures counted in a row, see mesh count above
Weft	Wire threads running down the width of the roll
Warp	Wire threads running down the length of the roll
Micron	1/1000 of a millimetre
Open Area	Percentage of free area in mesh or metal, see illustration above
Blinding	Blockage or restriction of the apertures of a sieve or filter by particles
Differential pressure	Pressure ratio upstream and downstream from the filter
Dry screening	Screening powdered materials without liquid
Mesh analysis	Separation of a bulk material sample and analysis of particle size
Mesh counter	Optical device used to establish mesh count
Mesh fineness	Number of wires per inch (Imperial measure)
Mesh thickness	Calculated according to wire diameter and mesh type
Service life	Operational life of a screen/mesh until it requires replacement
Square weave mesh	Mesh woven with wires spaced at a distance, giving open apertures
Twilled weave	Mesh type giving small filter pores

# Metal Mesh

## Choosing the right materials

---

### Choosing the right materials

#### Stainless Steel

The majority of Sefar Metal Meshes are woven using stainless steel to DIN 1.4301 (AISI 304) or DIN 1.4401 (AISI 316).

We can produce woven wire meshes using special alloys and other weaveable materials to your specifications. Please contact us to discuss your requirements.

This table serves as an overview of the various material characteristics and is not a comprehensive list. It does not contain all information about the various alloys.

Austenitic stainless steels are not magnetic and used extensively (304, 316), 904L is resistant to seawater attack. Ferritic Stainless Steels are magnetic and nickel free (430). 310/330 grades are highly heat resistant.

Stainless Steel Type	Material code	Code	%C max	% N max	% Cr	% Ni	% Mo	Others %	Temp Resist. Deg. C
304	1.4304	X 5 CR Ni 18.9	0.04	0.1	18	9			450
304L	1.4306-07	X 2 Cr Ni Ti 189	0.02	0.1	19	9			450
316	1.4401	X5 Cr Ni Mo 18 10	0.04	0.1	17	11	2		450
316L	1.4404	X2 Cr Ni Mo 18 10	0.02	0.1	17	11	2		450
904L	1.4539	X 3 Cr Ni Mo N 17135	0.01		20	25	4.3	1.5 Cu	500
430	1.4016	X 8 Cr 17	0.04		16.5				450
310	1.4841	X 15 Cr Ni Si 25 20	0.2	0.1	25	20			1000
330	1.1864	X 12 Ni Cr Si 36 16	0.05	0.1	17	36			1000

#### 304 Grade Stainless Steel

Grade 304 has excellent corrosion resistance in a wide range of media. It resists ordinary rusting in most architectural applications. It is also resistant to most food processing environments, can be readily cleaned, and resists organic chemicals, dye stuffs and a wide variety of inorganic chemicals. Typical applications for 304 include architecture, food and beverage processing, equipment and utensils, commercial and domestic kitchen construction, sinks, and equipment for chemical, petrochemical, mineral processing and other industries.

#### 316 Grade Stainless Steel

Grade 316 has excellent corrosion resistance in a wide range of media. Its main advantage over grade 304 is its increased ability to resist pitting and crevice corrosion in warm chloride environments. Typical applications for 316 include boat fittings and structural members; architectural components particularly in marine, polluted or industrial environments; food and beverage processing equipment; hot water systems; and equipment for chemical, petrochemical, mineral processing, photographic and other industries. Although 316 is often described as the 'marine grade', it is also seen as the first step up from the basic 304 grade

#### Other available materials

We also offer a wide range of other alloys, produced to individual customer specifications.

Group	Material Designation
Heating Conducting Alloys	Nickel-Chromium steel, Alu-chromium
Special Alloys	Incoloy 800, 825, 625, 600
Nonferrous Metals	Copper, Brass, Tin Bronze, Nickel, Monel, Aluminium
Hastelloy	Hastelloy C4, B2, C270
Titanium	Titanium, Tantalum



# Metal Mesh

## Stainless Steel Maintenance and Protection

---

### Maintenance & Protection

- Off the machine condition
- Surface treatments
- Tea Staining
- Maintenance
- Cleaning guide

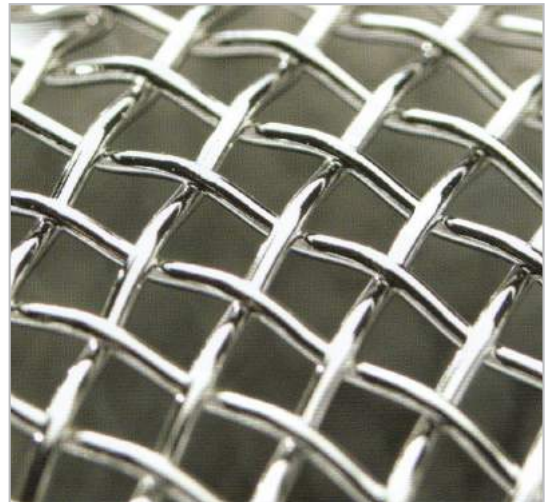

### Stainless Steel

Material that is supplied from Metal Mesh is in an “off the machine” condition meaning it will have residual oil and steel fragments from the process of weaving, perforation or fabrication.

In order to gain the quality outcome required for Stainless Steel, Sefar recommends the material is Pickled and Passivated after manufacture in order to clean all residual oil and steel fragments from the surface.

When the material is installed externally a maintenance program should be implemented to clean airborne particles from the surface. The method of cleaning will be dependent on where the material is installed, therefore, Sefar recommends sourcing such information from the Stainless Steel Association or a reputable surface finishing company.

Stainless Steel may suffer from ‘tea stains’ over time. Factors that accelerate this brown discolouration are wind exposure, pollution and elevated temperatures. This is a visual impairment only and will not affect the life or strength of the product.



Washing your Stainless Steel will reduce tea staining and should be an important project design consideration. Dependent on the location of the installation: warm soapy water washed off with cold water afterwards will be sufficient or an industrial cleaning product supplied by a reputable surface finisher may be suited in more harsh environments.

### Important:

- Do not use harsh scrubbing tools, scourers or chemicals
- Do not rub with steel wool or scrape with steel tools
- Do not use scourers or cleaning cloths that have been used on ordinary steel
- Do not use concentrated bleach or hydrochloric acid based cleaning products
- Stainless Steel may discolour if left in contact with salts or acids for extended periods

### Guide to the selection of Stainless Steel and the recommended cleaning intervals

Environment	Grade 304	Grade 316
Clean Inland	3-6 months	6 - 12 months
Polluted urban / industrial	Not suitable	6 - 12 months
Coastal / Marine	Not suitable	3 - 6 months

Rainwater is an effective natural cleaner.

Stainless Steel not exposed to the elements will require more frequent cleaning intervals.

# Metal Mesh - Illustration

## Stainless Steel Woven Wire Mesh

---

Examples (Pictures shown are as close as possible to scale)

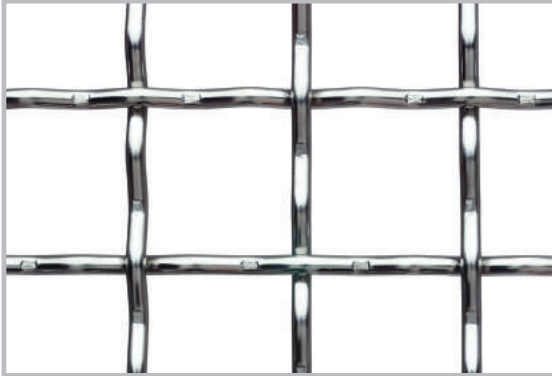

22.4mm Aperture x 3.15mm Wire Dia. / Intercrimped

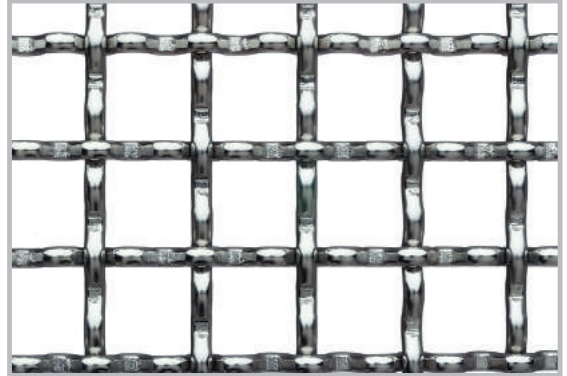

12.7mm Aperture x 3.0mm Wire Dia. / Intercrimped

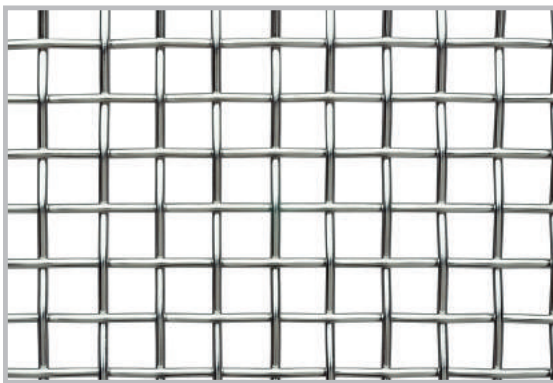

6.8mm Aperture x 1.6mm Wire Dia.

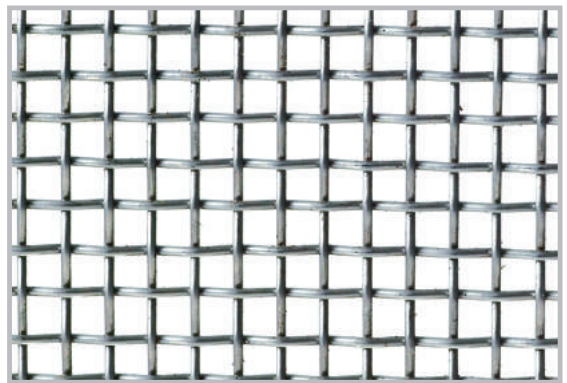

4.75mm Aperture x 1.6mm Wire Dia.

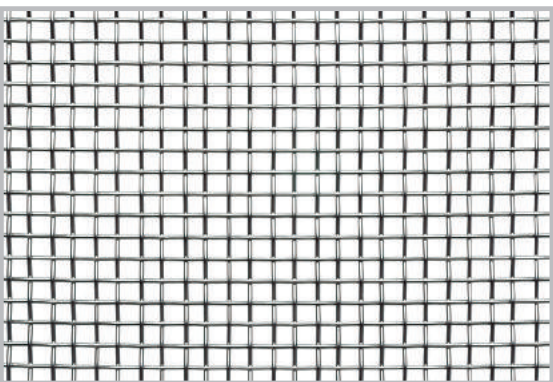

2.5mm Aperture x 0.75mm Wire Dia.

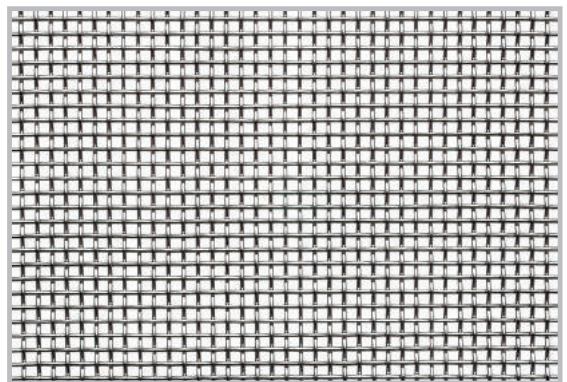

1.4mm Aperture x 0.71mm Wire Dia.

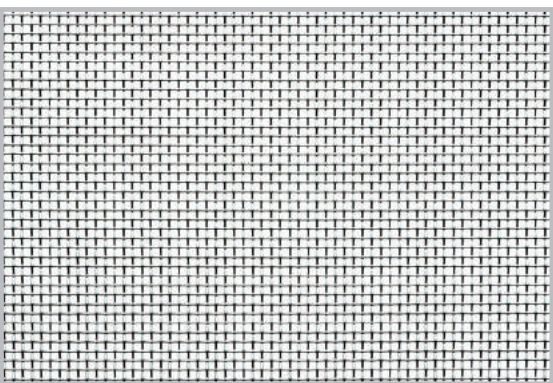

0.9mm Aperture x 0.375mm Wire Dia.

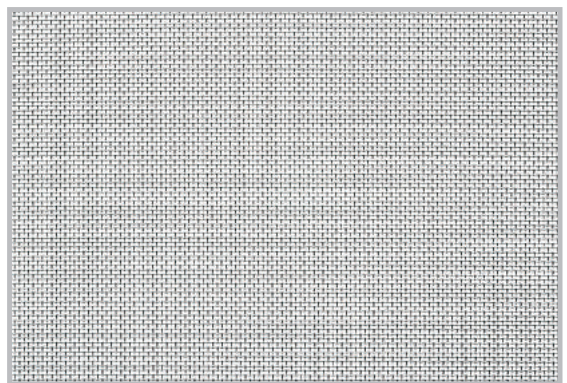

0.415mm Aperture x 0.22mm Wire Dia.

# Metal Mesh - Market Grade - Square Mesh Stainless Steel Woven Wire Mesh

## Overview

- Market Grade Stainless Steel Woven Wire Mesh is commonly used for industry
- Rolls up to 30m in length and 1550mm in width are available in stainless steel grade 304 and 316
- Mesh can be cut to specific size

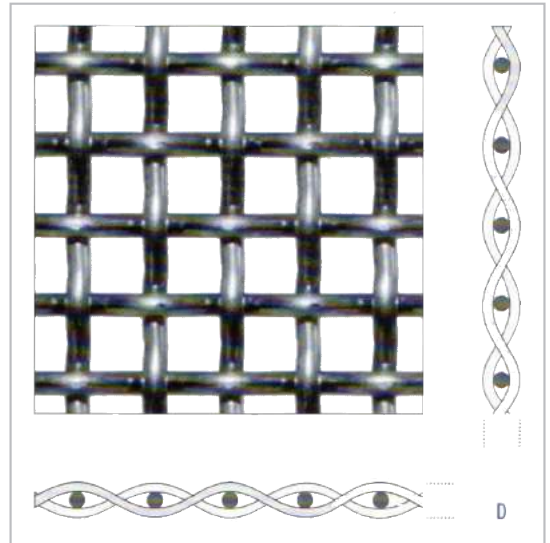

## Product Range overview

Part-Number	Material Grade	Aperture mm	Wire Dia. mm	Mesh Imp	SWG	Open Area %	Roll width mm	Weight kg per m
W00.6-8-122-6	316	35	4	1/C		77	2440x1220 Sheet	22.00
W001-10-127	304	22.4	3.15	1 I/C	10	77	1270	9.16
W001-10-124-6	316	22.4	3.15	1 I/C	10	77	1245	8.80
W001-10-155-6	316	22.4	3.15	1 I/C	10	77	1550	11.00
W0.75-12-127	304	16	2.5	0.75 I/C	12	75	1270	5.76
W0.75-12-124-6	316	16	2.5	0.75 I/C	12	75	1245	5.76
W001.6-10-127	304	12.7	3	1.6 I/C	10	65	1270	9.33
W001.6-10-124-6	316	12.7	3	1.6 I/C	10	65	1245	9.33
W002-16-124-I/C	304	11.2	1.6	2 I/C	16	77	1245	3.48
W002-16-124-6	316	11.2	1.6	2 I/C	16	77	1245	3.41
W002-14-127	304	10.6	2	2 I/C	14	70	1270	6.82
W002-14-124-6	316	10.6	2	2 I/C	14	70	1245	6.82
W002-12-127	304	10	2.5	2 I/C	12	63	1270	8.53
W002-12-124-6	316	10	2.5	2 I/C	12	63	1245	8.53
W002-12-155-6	316	10	2.5	2 I/C	12	63	1550	10.70
W003-16-124	304	6.8	1.6	3	16	67	1245	3.94
W003-16-124-6	316	6.8	1.6	3	16	67	1245	3.94
W003-14-124	304	6.3	2	3	14	57	1245	6.20
W003.5-18-155	304	6.1	1.2	3.5 I/C	18	69	1550	3.80
W004-19-124	304	5.3	1	4	19	71	1245	2.79
W004-18-124	304	5.1	1.2	4	18	65	1245	3.35
W004-18-155	304	5.1	1.2	4	18	65	1550	4.20
W004-16-124	304	4.75	1.6	4	16	55	1245	6.60
W004-16-124-6	316	4.75	1.6	4	16	55	1245	6.60
W005-18-124	304	3.9	1.2	5	18	58	1245	5.00
W005-16-124	304	3.5	1.6	5	16	46	1245	7.70
W005-16-155	304	3.5	1.6	5	16	46	1550	9.65

## Metal Mesh - Market Grade - Square Mesh Stainless Steel Woven Wire Mesh

### Product Range overview - Continued

Part-Number	Material Grade	Aperture mm	Wire Dia. mm	Mesh Imp	SWG	Open Area %	Roll width mm	Weight kg per m
W006-20-124	304	3.3	0.91	6	20	61	1245	3.27
W006-20-124-6	316	3.3	0.91	6	20	61	1245	3.27
W006-20-155	304	3.3	0.91	6	20	61	1550	4.10
W006-18-124	304	3	1.2	6	18	51	1245	6.05
W006-18-124-6	316	3	1.2	6	18	51	1245	6.05
W006-16-124	304	2.7	1.6	6	16	38	1245	9.60
W008-22-124-6	316	2.5	0.7	8	22	60	1245	2.68
W008-22-155	304	2.5	0.7	8	22	60	1550	3.37
W008-20-124	304	2.3	0.91	8	20	51	1245	4.40
W008-20-155	304	2.3	0.91	8	20	51	1550	5.52
W010-26-105	304	2.1	0.45	10	26	67	1050	1.45
W010-26-124	304	2.1	0.45	10	26	67	1245	1.68
W010-26-155	304	2.1	0.45	10	26	67	1550	2.10
W008-18-124	304	2	1.2	8	18	38	1245	5.81
W008-18-155-6	316	2	1.2	8	18	38	1550	7.27
W010-24-124-6	316	2	0.56	10	24	61	1245	2.40
W009-20-155	304	1.9	0.91	9	20	46	1550	5.70
W010-23-124	304	1.9	0.61	10	23	58	1245	2.58
W010-21-124	304	1.74	0.8	10	21	46	1245	6.00
W010-20-124	304	1.6	0.91	10	20	41	1245	6.55
W010-20-124-6	304	1.6	0.91	10	20	41	1245	6.55
W012-25-124	304	1.6	0.5	12	25	58	1245	2.02
W012-25-124-6	316	1.6	0.5	12	25	58	1245	2.02
W012-22-124	304	1.4	0.71	12	22	44	1245	4.07
W012-22-155	304	1.4	0.71	12	22	44	1550	5.10
W012-22-155-6	316	1.4	0.71	12	25	44	1550	5.10
W014-24-155	304	1.25	0.56	14	20	48	1550	3.00
W014-25-124	304	1.3	0.5	14	24	52	1245	2.35
W012-20-124	304	1.2	0.9	12	28	32	1245	5.39
W016-28-124	304	1.2	0.37	16	26	58	1245	1.40
W016-26-124	304	1.1	0.45	16	26	51	1245	2.20
W016-26-155	304	1.1	0.45	16	24	51	1550	2.76
W016-24-124	304	1	0.56	16	24	42	1245	3.42
W016-24-124-6	316	1	0.56	16	24	42	1245	3.42
W016-24-155	304	1	0.56	16	24	42	1550	4.35
W016-22-124	304	0.9	0.71	16	22	31	1245	4.32

## Metal Mesh - Market Grade - Square Mesh Stainless Steel Woven Wire Mesh

### Product Range overview - Continued

Part-Number	Material Grade	Aperture mm	Wire Dia. mm	Mesh Imp	SWG	Open Area %	Roll width mm	Weight kg per m
W020-28-124	304	0.9	0.37	20	28	50	1245	1.75
W020-28-124-6	316	0.9	0.37	20	28	50	1245	1.75
W020-28-155	304	0.9	0.37	20	28	50	1550	2.20
W020-26-124	304	0.81	0.45	20	26	41	1245	3.30
W020-26-124-6	316	0.81	0.45	20	26	41	1245	3.30
W020-26-155	304	0.81	0.45	20	26	41	1550	4.20
W024-30-124	304	0.75	0.31	24	30	49	1245	0.84
W020-24-124	304	0.71	0.56	20	24	31	1245	3.71
W024-26-124	304	0.6	0.45	24	26	32	1245	2.52
W024-26-155	304	0.6	0.45	24	26	32	1550	3.20
W030-32-124	304	0.57	0.27	30	32	46	1245	1.60
W030-30-155	304	0.53	0.31	30	30	39	1550	1.53
W030-30-124-6	316	0.53	0.31	30	30	39	1245	1.22
W040-34-124-6	316	0.415	0.22	40	34	42	1245	1.34
W040-34-155-6	316	0.415	0.22	40	34	42	1550	1.68
W050-36-124-6	316	0.31	0.2	50	36	38	1245	1.34
W050-36-155-6	316	0.31	0.2	50	36	38	1550	1.68
W060-37-124-6	316	0.26	0.16	60	37	35	1245	1.06
W060-37-155-6	316	0.26	0.16	60	37	35	1550	1.33
W070-38-124-6	316	0.21	0.15	70	38	34	1245	0.96
W070-38-155	304	0.21	0.15	70	38	34	1550	1.20
W070-38-155-6	316	0.21	0.15	70	38	34	1550	1.20
W080-39-124-6	316	0.19	0.125	80	39	34	1245	0.88
W080-39-155-6	316	0.19	0.125	80	39	34	1550	1.10
W100-42-124-6	316	0.15	0.1	100	42	36	1245	0.68
W100-42-155	304	0.15	0.1	100	42	36	1550	0.86
W100-42-155-6	316	0.15	0.1	100	42	36	1550	0.86
W120-44-124-6	316	0.13	0.08	120	44	37	1245	0.60
W120-44-152-6	316	0.13	0.08	120	44	37	1520	0.76
W140-45-122	304	0.11	0.071	140	45	37	1220	0.47
W150-45-124-6	316	0.1	0.063	150	45	37	1245	0.43
W150-45-155-6	316	0.1	0.063	150	45	37	1550	0.54
W200-47-124-6	316	0.08	0.05	200	47	38	1245	0.35
W200-47-155-6	316	0.08	0.05	200	47	38	1550	0.44
W250-48-155-6P	316	0.063	0.04	250	48	38	2000	0.34
W250-48-200-6T	316	0.063	0.04	250	48	38	2000	0.45

## Metal Mesh - Market Grade - Square Mesh Stainless Steel Woven Wire Mesh

### Product Range overview - Continued

Part-Number	Material Grade	Aperture mm	Wire Dia. mm	Mesh Imp	SWG	Open Area %	Roll width mm	Weight kg per m
W300-49-124-6P	316	0.055	0.03	300	49	32	1245	0.22
W300-48-124-6T	316	0.053	0.04	270	48	32	1245	0.26
W325-49-124-6P	316	0.045	0.032	325	49	34	1245	0.20
W350-50-124-6P	316	0.047	0.025	350	50	43	1245	0.16
W400-49-124-6T	316	0.034	0.03	400	49	27	1245	0.17
W400-49-200-6T	316	0.034	0.03	400	49	27	2000	0.23
W500-50-124-6T	316	0.025	0.025	500	50	25	1245	0.14



# Metal Mesh - Bushfire Mesh

## Woven Wire Mesh for Radiant Heat and Ember Protection

### Overview

- Available in 304 and 316 grade stainless steel
- Available in rolls and cut pieces
- Standard roll widths 1245mm
- Used for protection of homes in bushfire prone areas

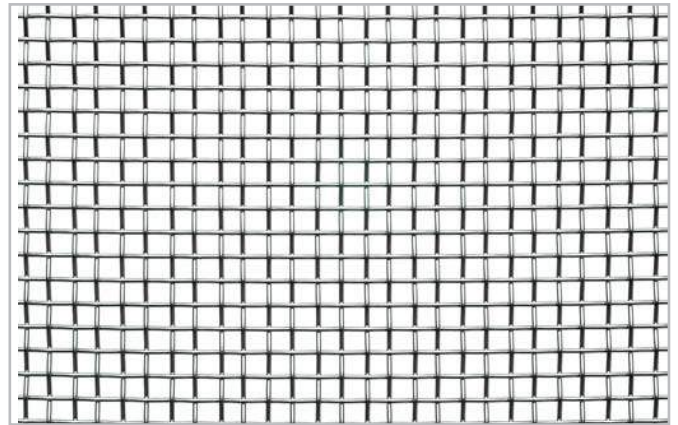

### Stainless Steel Woven Bushfire Mesh - Radiant Heat

Part-Number	Material Grade	Aperture mm	Wire Dia. mm	Mesh Imp	SWG	Open Area %	Roll width mm	Weight kg per m
W010-20-124	304	1.6	0.91	10	20	41	1245	6.55
W010-20-124-6	316	1.6	0.91	10	20	41	1245	6.55

#### Fire Test on attenuation of radiant heat flux:

Using a test procedure given in AS 1530 section 8.1 the mesh has been evaluated using a radiant heat flux exposure of up to and including 40kW/m<sup>2</sup> (BAL 40). The attenuation of the radiant heat flux provided by the mesh was approximately 50%. AS 3959 section 9.5.1.A 'Construction of Buildings in Bushfire Prone Areas' 2009 The mesh has been tested in accordance with this standard and complies with and meets the dimensional requirements of the standard as it has an aperture of less than 2mm.

### Stainless Steel Woven Ember Mesh

Part-Number	Material Grade	Aperture mm	Wire Dia. mm	Mesh Imp	SWG	Open Area %	Roll width mm	Weight kg per m
W009-20-155	304	1.9	0.91	9	20	46	1550	5.70
W010-20-124	304	1.6	0.91	10	20	41	1245	6.55
W010-20-124-6	316	1.6	0.91	10	20	41	1245	6.55
W010-21-124	304	1.74	0.8	10	21	46	1245	6.00
W010-23-124	304	1.9	0.61	10	23	58	1245	2.58
W012-22-124	304	1.4	0.71	12	22	44	1245	4.07
W012-22-155	304	1.4	0.71	12	22	44	1550	5.10
W012-22-155-6	316	1.4	0.71	12	25	44	1550	5.10
W012-25-124	304	1.6	0.5	12	25	58	1245	2.02
W012-25-124-6	316	1.6	0.5	12	25	58	1245	2.02

To protect against ember attack in accordance with the Australian Standard AS 3959-2009 'construction of building in bushfire-prone areas' a corrosion resistant steel mesh must be used with an aperture of less than 2mm.

## Metal Mesh - Bolting Cloth

### Stainless Steel Bolting Cloth for high capacity sifting and screening applications

#### Overview

- Stainless Steel Bolting Cloth is commonly used for high capacity sifting and screening applications where increased throughput is important
- The increased open area, compared to common Market Grade Woven Wire Mesh, is achieved by using thinner wires
- This results in reduced service life
- Our consultants can work together with you to specify the best possible option in between open area and service life to suit your individual screening or sifting application
- Material width typically 1220 and 1580mm wide
- Material quality 316 grade stainless steel
- Food grade quality available
- Magnetic type material available upon request

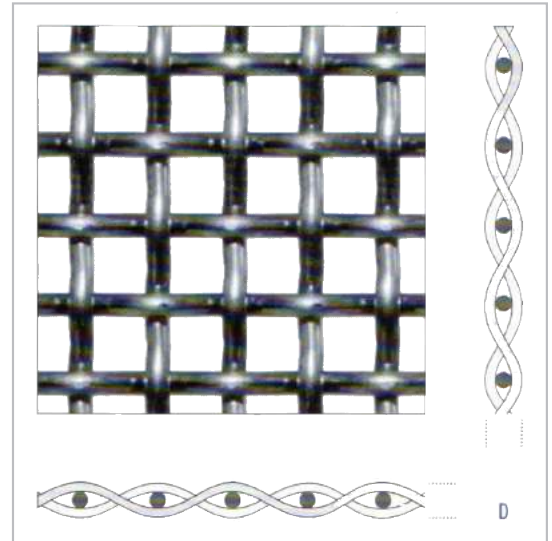

#### Product Range overview

Part-Number	Material Grade	Aperture mm	Wire Dia. mm	Mesh Imp	SWG	Open Area %	Roll width mm	Weight kg per m
BC0950-1580	316	0.95	0.22	22	36	66	1580	0.70
BC0850-1580	316	0.85	0.22	24	34	63	1580	0.76
BC0670-1220	316	0.67	0.16	30(31)	38	65	1220	0.48
BC0540-1580	316	0.54	0.165	36	38	59	1580	0.75
BC0440-1580	316	0.44	0.14	44	39	57	1580	0.67
BC0390-1530	316	0.39	0.14	48	39	54	1530	0.73
BC0320-1530	316	0.32	0.114	58	41	55	1530	0.57
BC0310-1580	316	0.31	0.114	60	41	53	1580	0.59
BC0280-1580	316	0.28	0.1	66	42	54	1580	0.53
BC0265-1580	316	0.265	0.09	72	43	54	1580	0.56
BC0240-1530	316	0.24	0.09	76	43	52	1530	0.59
BC0220-1580	316	0.22	0.09	80	43	50	1580	0.62
BC0150-1580	316	0.15	0.065	120	45	47	1580	0.48
BC0130-1580	316	0.13	0.06	135	46	47	1580	0.45
BC0130-2000	316	0.13	0.06	135	46	47	2000	0.62
BC0105-1580	316	0.105	0.05	165	47	47	1580	0.32
BC0075-1530	316	0.075	0.036	230	48	43	1530	0.50



## Metal Mesh - Bolting Cloth

### Stainless Steel Bolting Cloth for high capacity sifting and screening applications

---

Please see page 5 - 6 for more information about

- Selection of the right mesh for the right application
- Better Screening - Hints and Tips

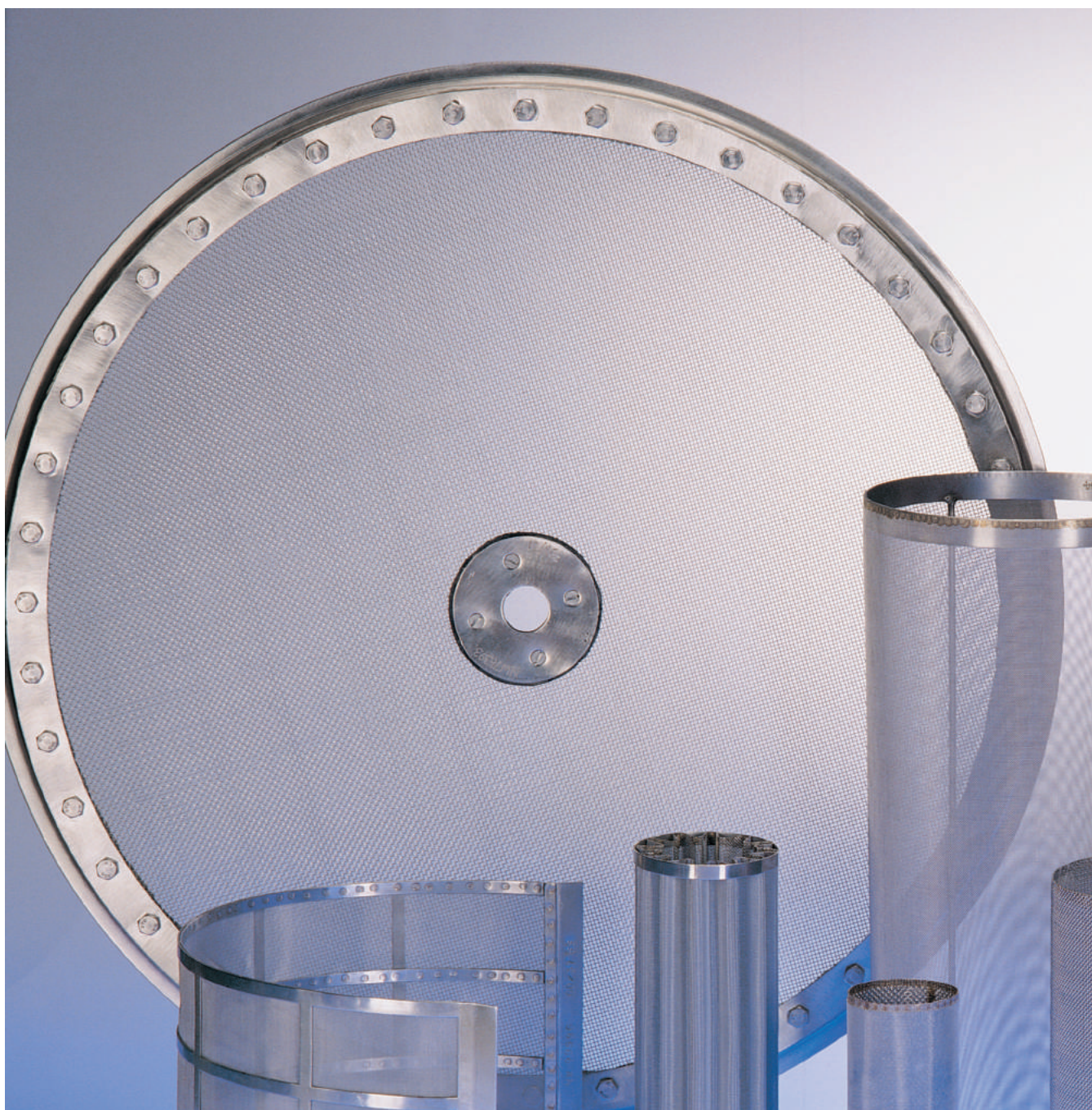

# Metal Mesh - Woven Wire Mesh / FDA Compliant

## Stainless Steel Woven Wire Mesh for Food contact applications

### Overview

- Material quality 304 grade stainless steel
- Food compliant, mesh is ultrasonically cleaned and free of grease, oils and dirt
- Premium quality product - Made in Europe
- Ideal for all applications where the mesh is in contact with food products
- Available in rolls - up to 50m length
- Standard roll width 1580mm

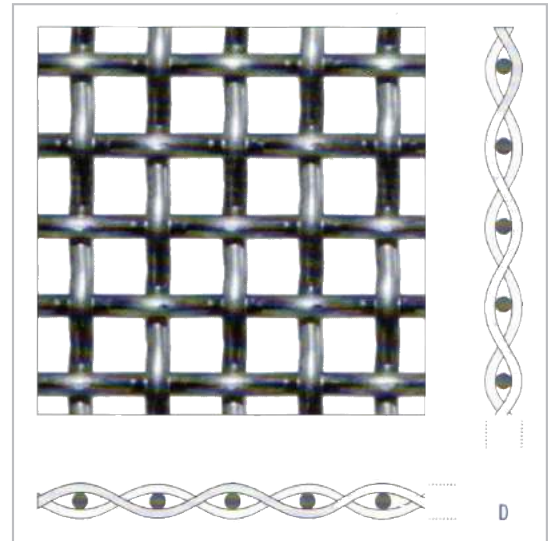

### Product Range overview

Part-Number	Material Grade	Aperture mm	Wire Dia. mm	Mesh Imp	Open Area %	Roll width mm	Weight kg per m
26-2000/64-1580	304	2.0	0.50	11	64	1580	1.42
26-2000/74-1580	304	2.0	0.32	11	74	1580	1.32
26-1800/58-1580	304	1.8	0.56	12	58	1580	1.7
26-1800/72-1580	304	1.8	0.32	12	72	1580	1.45
26-1600/58-1580	304	1.6	0.50	12	58	1580	0.75
26-1600/77-1580	304	1.6	0.22	14	77	1580	0.52
26-1400/57-1580	304	1.4	0.45	14	57	1580	0.91
26-1400/74-1580	304	1.4	0.22	16	74.5	1580	0.61
26-1250/57-1580	304	1.25	0.40	16	57	1580	0.81
26-1250/72-1580	304	1.25	0.22	17	72	1580	0.65
26-1180/56-1580	304	1.18	0.40	16	56	1580	0.80
26-1180/71-1580	304	1.18	0.22	18	71	1580	0.70
26-1120/61-1580	304	1.12	0.315	18	61	1580	0.82
26-1120/69-1580	304	1.12	0.22	19	69.4	1580	0.73
26-1060/68-1580	304	1.06	0.22	20	68.6	1580	0.79
26-1000/58-1580	304	1.0	0.315	20	58	1580	0.81
26-1000/67-1580	304	1.0	0.22	21	67	1580	0.72
26-950/56-1580	304	0.95	0.315	21	56	1580	0.79
26-950/68-1580	304	0.95	0.20	22	68.2	1580	0.70
26-900/55-1580	304	0.9	0.315	23	55	1580	0.81
26-900/67-1580	304	0.9	0.20	23	67	1580	0.72
26-850/63-1580	304	0.85	0.224	24	63	1580	0.68
26-850/65-1580	304	0.85	0.20	24	65	1580	0.76
26-800/58-1580	304	0.8	0.25	24	58	1580	0.90
26-800/64-1580	304	0.8	0.20	26	64	1580	0.82
26-750/65-1580	304	0.75	0.18	28	65	1580	0.72

# Metal Mesh - Woven Wire Mesh / FDA Compliant

## Stainless Steel Woven Wire Mesh for Food contact applications

### Product Range overview - Continued

Part-Number	Material Grade	Aperture mm	Wire Dia. mm	Mesh Imp	Open Area %	Roll width mm	Weight kg per m
26-710/64-1580	304	0.71	0.18	30	64	1580	0.60
26-670/65-1580	304	0.67	0.16	31	65	1580	0.48
26-630/64-1580	304	0.63	0.16	32	64	1580	0.48
26-600/62-1580	304	0.6	0.16	34	62	1580	0.81
26-560/60-1580	304	0.56	0.16	36	60	1580	0.75
26-530/59-1580	304	0.53	0.16	38	59	1580	0.78
26-500/57-1580	304	0.50	0.16	40	57	1580	0.67
26-475/56-1580	304	0.475	0.16	42	56	1580	0.65
26-450/57-1580	304	0.45	0.14	44	57	1580	0.67
26-425/56-1580	304	0.425	0.14	46	56	1580	0.73
26-400/54-1580	304	0.40	0.14	48	54	1580	0.73
26-375/53-1580	304	0.375	0.14	50	53	1580	0.74
26-355/51-1580	304	0.355	0.14	53	51	1580	0.80
26-335/49-1580	304	0.335	0.14	55	49.7	1580	0.50
26-315/54-1580	304	0.315	0.112	60	54	1580	0.59
26-300/53-1580	304	0.30	0.112	62	53	1580	0.62
26-280/51-1580	304	0.28	0.112	65	51	1580	0.53
26-265/53-1580	304	0.265	0.100	70	52.8	1580	0.52
26-250/53-1580	304	0.25	0.100	75	53	1580	0.57
26-245/62-1580	304	0.245	0.065		62	1580	0.43
26-236/51-1580	304	0.236	0.100	76	51	1580	0.59
26-224/49-1580	304	0.224	0.100	80	49	1580	0.62
26-212/49-1580	304	0.212	0.09	84	49	1580	0.42
26-180/45-1580	304	0.18	0.09	94	45	1580	0.61
26-160/46-1580	304	0.16	0.075	108	46	1580	0.55
26-140/46-1580	304	0.14	0.067	120	46	1580	0.48
26-132/49-1580	304	0.132	0.065	135	49	1580	0.45
26-125/48-1580	304	0.125	0.056	140	48	1580	0.40
26-106/36-1580	304	0.106	0.050	163	36	1580	0.32

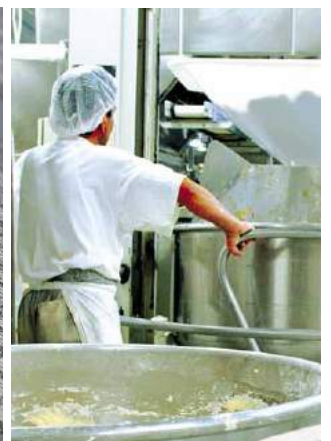
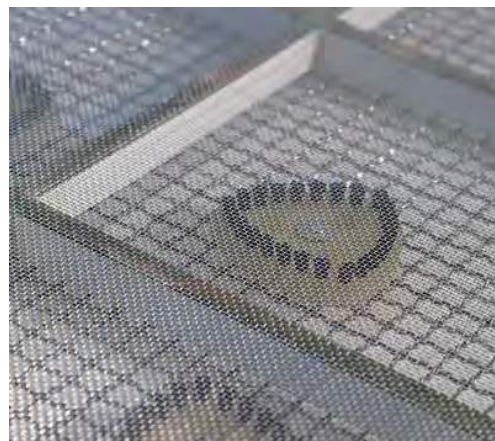

# Metal Mesh - Hollander Weave

## Stainless Steel Hollander Weave for Liquid Filtration applications

### Overview

- Stainless Steel Hollander Weave Woven Wire Mesh is available in 304 and 316 grade stainless steel
- Available in rolls
- Standard roll width 1220mm
- Used for fine filtration of liquid products
- Good flow rates and even openings
- These meshes have a slightly textured surface and are particularly useful for high flow rates and low pressure loss. They are used where mechanical loading is increased, such as for settling filters and filter candles.
- Ideal for remeshing of Filter Leaves

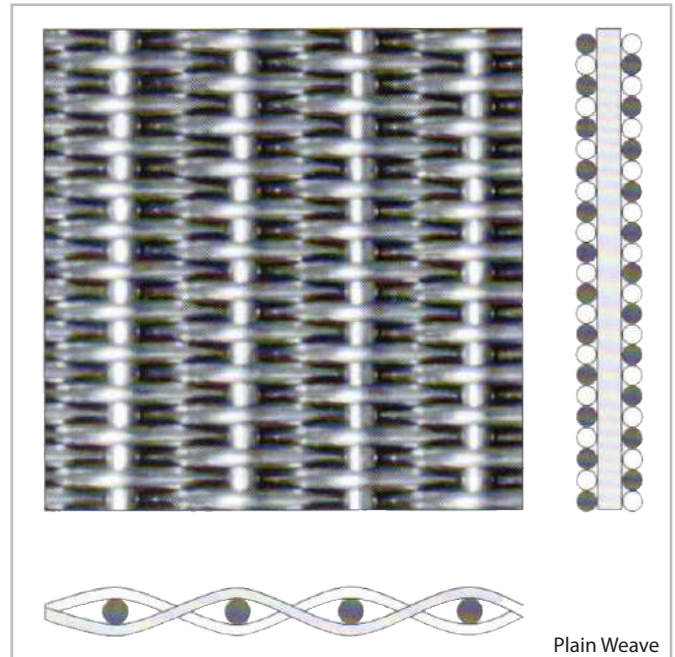

### Product Range overview

Part-Number	Material Grade	Nominal Filter Rating	Absolute Filter Rating	Imperial Warp/Weft Mesh	Equivalent Warp/Weft Wire Dia. mm	Weave Type	Roll width mm	Weight per m
WHW12/64-122	304	200	290	12/64	0.6/0.42	PLAIN	1220	5.76
WHW14/88-122	304	150	240	14/88	0.5/0.33	PLAIN	1220	4.82
WHW20/250-122	304	100	120	20/250	0.25/0.20	TWILL	1220	5.08
WHW24/110-127	316	80	125	24/110	0.36/0.26	PLAIN	1270	4.36
WHW24/110-137	316	80	125	24/110	0.36/0.26	PLAIN	1370	4.62
WHW24/110-155	316	80	125	24/110	0.36/0.26	PLAIN	1550	5.10
WHW30/150-122	304	65	105	30/150	0.23/0.18	PLAIN	1220	2.97
WHW40/200-122	304	55	75	40/200	0.18/0.14	PLAIN	1220	2.59
WHW50/250-122	304	40	63	50/250	0.14/0.112	PLAIN	1220	2.26
WHW80/400-122	316	35	45	80/400	0.125/0.071	PLAIN	1220	2.00
WHW80/700-122	316	25	38	80/700	0.1/0.076	TWILL	1220	2.44
WHW80/700-122A	304	25	38	80/700	0.1/0.076	TWILL	1220	2.44
WHW165/800-122	316	15	26	165/800	0.07/0.05	TWILL	1220	1.91
WHW165/1400-122	316	10	18	165/1400	0.07/0.04	TWILL	1220	1.93
WHW200/1400-122	316	5	14	200/1400	0.07/0.04	TWILL	1220	1.99

Please see pages 5-6 for more information about:

- Selection of the right mesh for the right application
- Better Screening - Hints and Tips

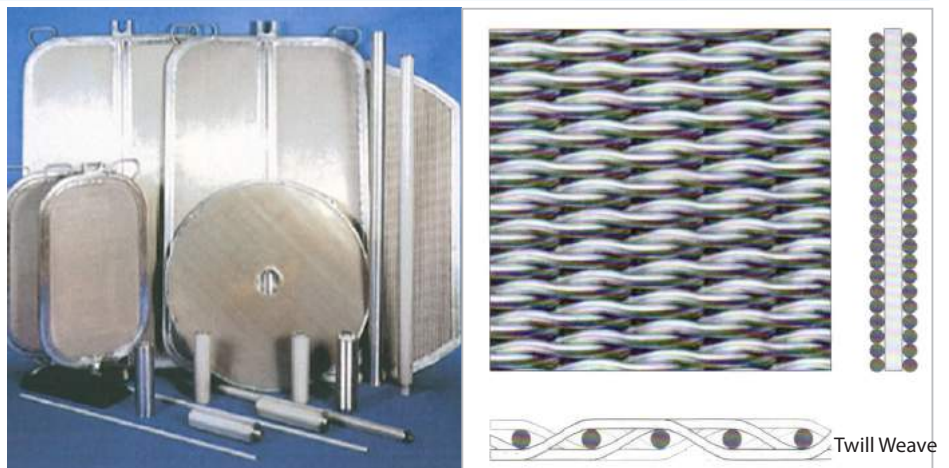

# Metal Mesh Extruder Discs

## Single Screen Filters - Spot Welded Screen Packs - Rim Screen Packs

---

### Features

- Precision punched to exact diameter
- Single or multi-layer design
- Available in most mesh types
- Available in virtually any diameter

### Applications

Woven Wire Mesh Discs are used as part of the extrusion process in the following industries:

- Polymers
- Cable manufacturing
- Hose manufacturing

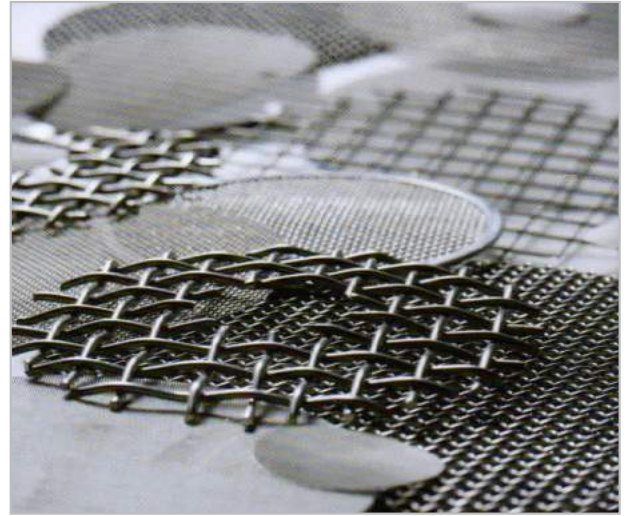

Metal Mesh Discs are manufactured using high grade woven wire meshes. Precision punched for a perfect fit and easy to install and remove.

The high grade stainless steel mesh provides optimal classification performance and batch-to-batch end-product consistency.

In addition we can also produce screen packs consisting of multiple layers of woven wire mesh that are spot-welded together.

### Disc Typical Sizes - punched discs

Diameter mm	Heaviest wire type	
Min 8mm - Max. 326mm	SWG 22	0.71 mm

Laser cut discs available in most diameters and mesh sizes

# Metal Mesh - Woven Wire Rectangular / Oblong Mesh

## Rectangular Woven Wire Mesh

### Overview

- Available in 304 and 316 grade stainless steel and galvanised mild steel
- Ideal for fencing, balustrades, cladding, ceilings, security applications
- Aperture sizes fully variable, available from 0.8x7mm up to 75x125mm
- Standard wire diameters available
- Combination of different wire diameters possible
- Available in roll form or cut to size
- Long way of aperture can run either way, eg length or width of mesh size
- All products are made to order

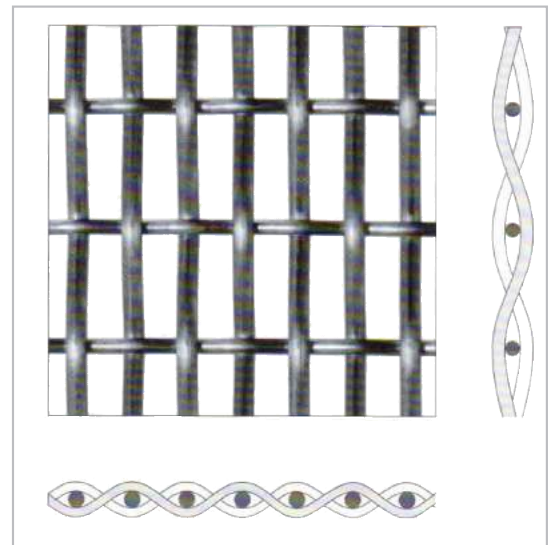

### Common configurations

Part-Number	Material Grade	Aperture mm	Wire Dia. mm	Open Area %	Roll width up to mm	Roll length m	Weight kg per m
WWMR 1.25x10APx1.25W	304, 316, GAL	1.25x10	1.25	45	2400	25	4.85
WWMR 2.8x20APx1.6x2W	304, 316, GAL	2.8x20	1.6x2.0	57	2400	25	4.8
W03.15x25-124	304	3.15x25	2.5	80	1245	30	6.1
WWMR 7.5x25.4APx3.15W	304, 316, GAL	7.5x25.4	3.15	63	2400	25	8.15
WWMR 7.8x26APx2.5W	304, 316, GAL	7.8x26	2.5	69	2400	25	6.1
WWMR 10x30APx3.15W	304, 316, GAL	10x30	3.15	69	2400	25	7.4
WWMR 10x40AOx3.15W	304, 316, GAL	10x40	3.15	72	2400	25	6.5

### Wire & Aperture Size / Slot Size selection options

Part-Number	Material Grade	Aperture mm	Wire Dia. mm	Roll width up to mm	Roll length m
WWMR 1.25	304, 316	0.8x7.0 - 75x125	1.25, 1.6, 2.0, 2.5, 3.15	2400	25
			4.0, 5.0, 6.3	1800	
WWMR	GAL	0.8x7.0 - 75x125	1.6, 2.5	2400	25

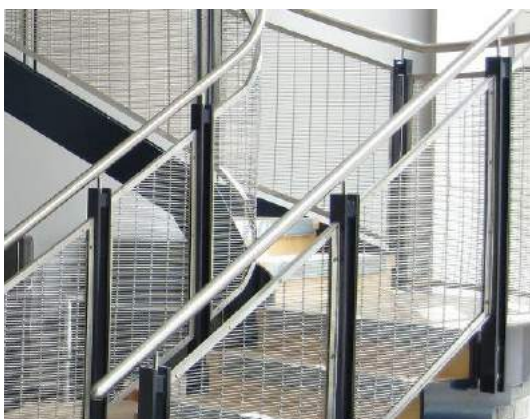

# Metal Mesh - Welded Wire Mesh

## Welded Wire Mesh - Rolls

### Overview

- Welded Wire Mesh Rolls are available in 304 and 316 grade stainless steel
- Available cut to size

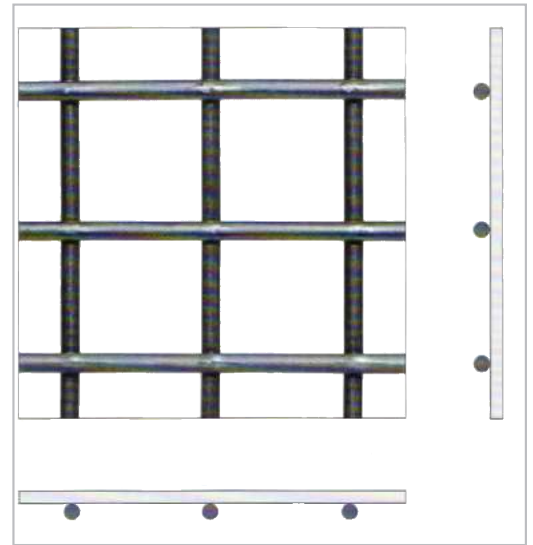

### Product Range overview

Part-Number	Material Grade	Aperture mm	Wire Dia. mm	Pitch mm	Roll width mm	Weight kg per m
WLD-6.35-0.8	304	5.55	0.8	6.35	1220	1.40
WLD-10-0.8	304	9.2	0.8	10	1220	1.00
WLD-12.7-1.2	304	11.5	1.2	12.7	1220	1.70
WLD-12.7-1.6	304	11.1	1.6	12.7	1220	3.10
WLD-12.7-1.6-6	316	11.1	1.6	12.7	1220	3.10
WLD-18-2	304	16	2	18	1220	3.75
WLD-25-1.2	304	24.2	1.2	25.4	1220	1.80
WLD-25-1.6	304	23.8	1.6	25.4	1220	2.40
WLD-25-1-6	316	24.4	1	25.4	1220	1.00
WLD-25-2	304	23.4	2	25.4	1220	3.00
WLD-25-2-6	316	23.4	2	25.4	1220	3.00
WLD-50-2-6	316	48	2	50	1220	1.00



# Metal Mesh - Welded Wire Mesh

## Welded Wire Mesh - Sheets

### Overview

- Welded Wire Mesh Sheets are available in 304 and 316 grade stainless steel and galvanised mild steel
- Available cut to size

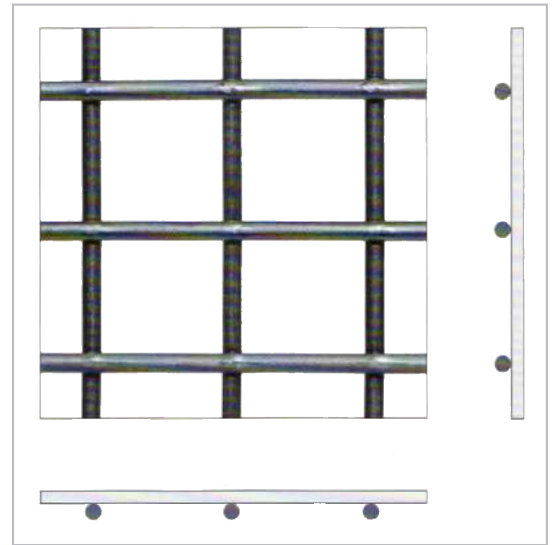

### Product Range overview

Part-Number	Material Grade	Aperture mm	Wire Dia. mm	Pitch mm	Sheet Size mm	Weight kg
WLD-25-3	304	21.85	3.15	25	2000x1000	12.00
WLD-25-3A	304	21.85	3.15	25	2400x1200	13.50
WLD-25-3-6	316	21.85	3.15	25	2500x1200	13.50
WLD-40-4	304	36	4	40	2400x1200	10.00
WLD-50-3	304	47	3	50	2500x1200	8.00
WLD-50-4	304	46	4	50	2000x1000	8.00
WLD-50-4A	304	46	4	50	2400x1200	12.00
WLD-50-4-6	316	46	4	50	2500x1200	12.00
WLD-100-3	304	96.85	3.15	100	2500x1200	4.00
WLD-100-6	304	94	6	100	2500x1200	14.00
WLDGAL-25-3	GAL	22.2	3.2	25.4	2500x1200	18.00
WLDGAL-50-3	GAL	47	3	50	2500x1200	8.00
WLDGAL-50-4	GAL	46	4	50	2500x1200	12.00
WLDGAL-100-6	GAL	94	6	100	2500x1200	12.70





# Metal Mesh - Brass

## Brass Woven Wire Mesh

### Overview

- Brass Woven Wire Mesh for decorative applications
- Available in rolls and cut pieces
- Standard roll widths 1220mm
- Other meshes available upon request

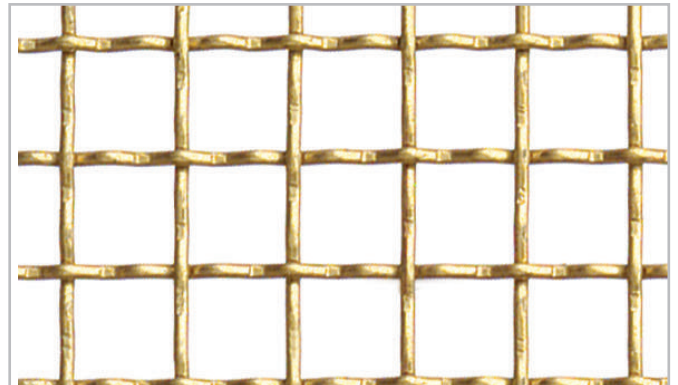

### Product Range overview

Part-Number	Material Grade	Aperture mm	Wire Dia. mm	Mesh Imp	SWG	Open Area %	Roll width mm	Weight kg per m
WB002-16-122	BRASS	11.2	1.6	2 I/C	16	70	1220	3.42
WB004-16-122	BRASS	4.7	1.6	4	16	55	1220	6.6
WB006-18-122	BRASS	3	1.2	6	18	51	1220	6.05
WB006-20-122	BRASS	3.3	0.91	6	20	61	1220	3.27



### Surface Finish:

Please note that any Brass product will change its surface appearance over time due to exposure to air (oxydation). Differences in surface finish can also be observed from roll to roll.

Metal Mesh - Perforated Metals  
Product Range



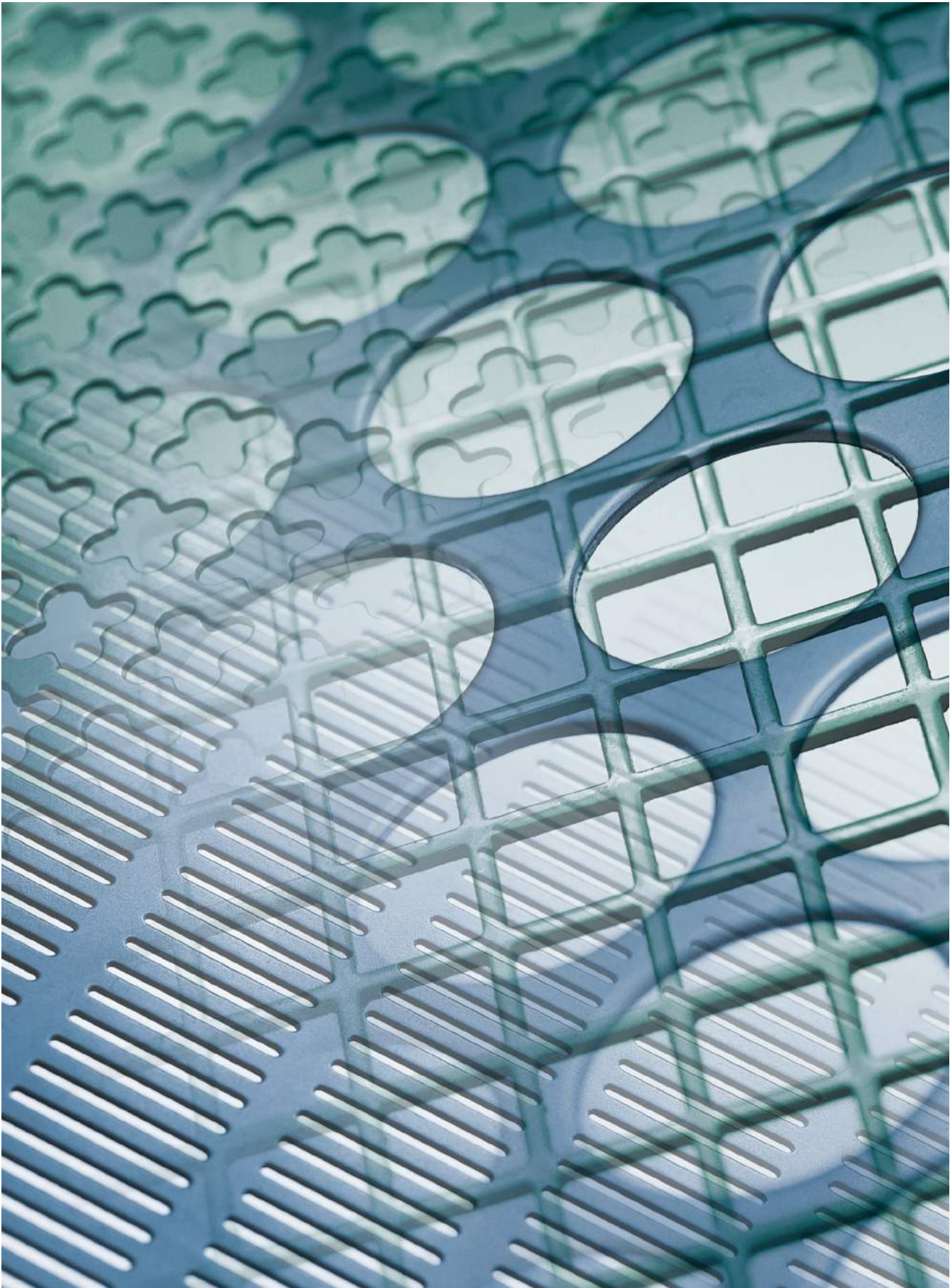

---

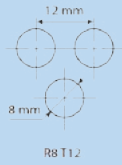
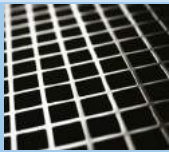
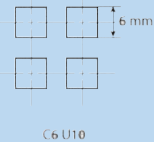

# Metal Mesh

## Perforated Metals - Principles & Terminology

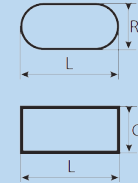
### Perforation Types / Product examples and Applications

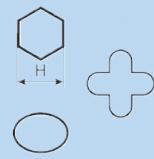
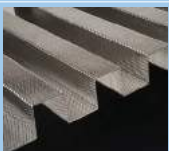
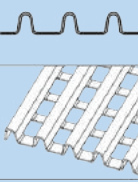
Round Holes	Type R	Quality	Product examples	Main applications
		The staggered arrangement of the holes provides optimum mechanical strength combined with a personalised design. For sorting and sifting industries, the staggered arrangement aids efficiency.	Filter elements, strainer Spacers for autoclaves Drying trays, speakers Lighting, Furnishings, Displays...	Filtration, separation, ventilation, bracketing, screening, isolation, air conditioning, absorption, sound insulation, decoration, drying, protection, shredding, sorting, grading, urban development
Square Holes	Type C	Quality	Product examples	Main applications
		Any square holes arranged in perpendicular perforation lines allows the achievement of a full square or rectangular perforated area.	Industrial components, Filter elements, Baskets treatment and sterilisation, Displays, ceilings, partition systems, sunshades, trommel screens, ovens, food, laboratory sieves, hoods, substructures, drying racks	Carterisation, acoustic cladding, calibration, screening, separation, drying, ventilation, skinning and styling...
Slotted	Type LR / LC	Quality	Product examples	Main applications
		The long hole has the property to minimise the clogging of screening and sorting installations.	Industrial components, pallets for drying, radiator covers, filter elements, ceilings, railings, electric carrier components, fish grids, cable holder, carterisation, calibrating seed	Separation, drying, ventilation, calibration, rollover...
Decorative	Type H/O/DEC	Quality	Product examples	Main applications
		Specific range of perforated products we can find traces in the last greatest architectural achievements in Europe and the world. Innovative materials with great precision leaving full creative freedom for imagination.	All uses with perforations. Computer rack, railings, etc...	Possible to achieve the effects of opacity and transparency more or less pronounced depending on the desired atmosphere. Multiple opportunities, both in the choice of motifs, materials, surface treatments, give these models an extreme adaptability
Ribbed	Type TN/TPN	Quality	Product examples	Main applications
		Ribbed Perforated plates combine rigidity, transparency and aesthetics. They thus offer Designers & Architects very creative freedom while bringing an unusual touch.	Media filter, blinds, walls, signs, street furniture, grills, metal ceilings, lighting, wall coverings, partitions	Drying, ventilation, cladding, protection, anti vandal screens...

### Terminology - Perforated Metals

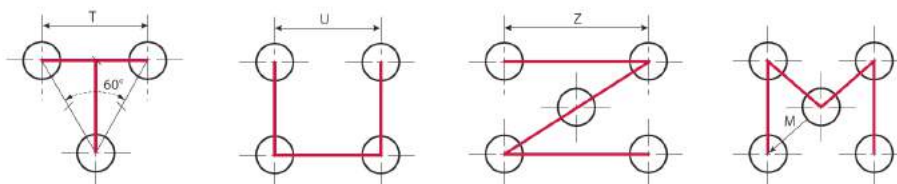

Pitch: Distance from centre to centre of holes. The arrangement and pitch of holes are codified by letters T-U-M-Z in relation to geometrical disposition of holes. The direction depends upon the situation of holes in relation to the length of the plate. Two directions : A or B.

Open Area: The Open Area is the percentage of free area in perforated metal.

# Metal Mesh - Perforated Metal

## Round Holes - Illustration of Perforation

R0.5 T1 23% - 0.5mm hole	R0.8 T1.5 25% - 0.8mm hole	R1 T2 23% - 1mm hole	R1.5 T2.75 26% - 1.5mm hole
R2 T3 40% - 2mm hole	R2 T3.5 30% - 2mm hole	R2 T4 23% - 2mm hole	R3 T4 50% - 3mm hole
R3 T5 32% - 3mm hole	R3 T6 23% - 3mm hole	R4 T5 58% - 4mm hole	R4 T6 40% - 4mm hole
R4 T8 23% - 4mm hole	R5 T7 45% - 5mm hole	R5 T8 35% - 5mm hole	R5 T10 23% - 5mm hole

# Metal Mesh - Perforated Metal

## Round Holes - Illustration of Perforation

---

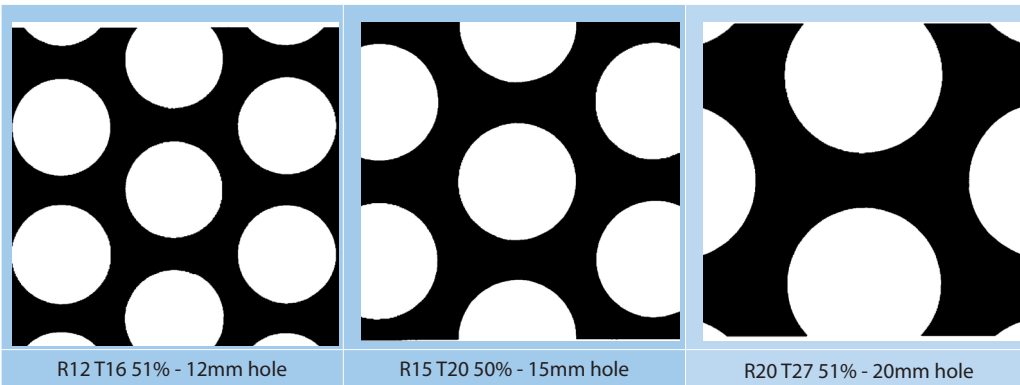
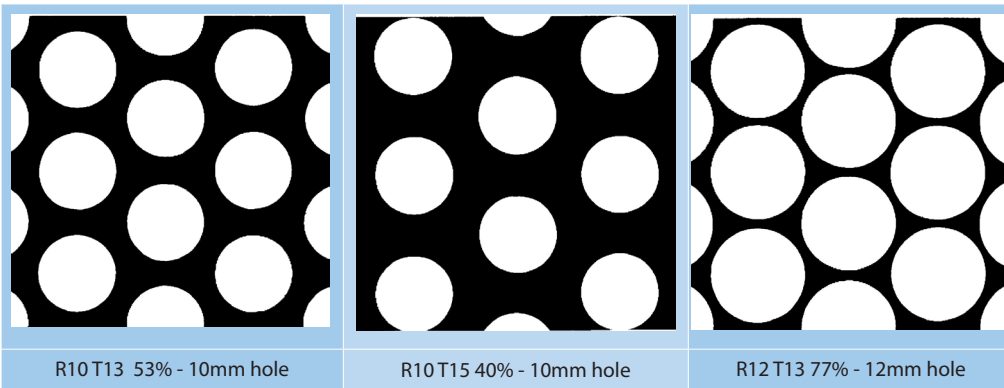
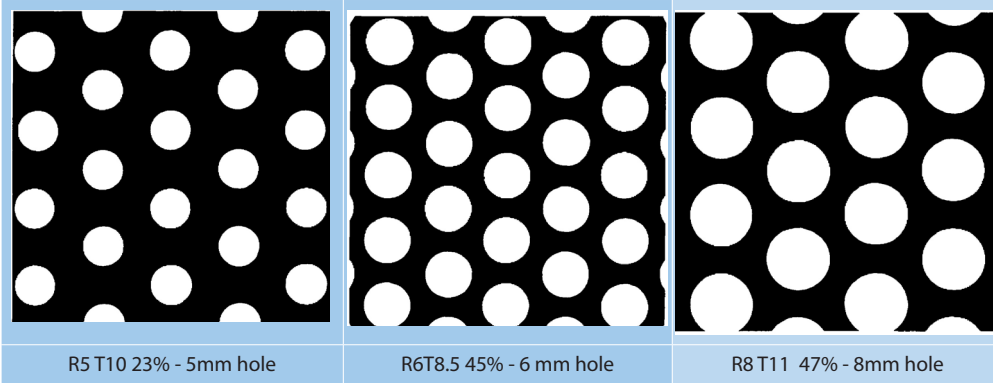

# Metal Mesh - Perforated Metal

## Round Holes - Stainless Steel

### Overview

- Made in Europe - Premium Quality
- Stainless Steel grade 304 and 316L
- Sheet sizes 1000x2000 or 1250x2500mm
- Burr free, flat sheets



### Product Range overview

Part-Number	Material Grade	Hole size mm	Pitch mm	Open Area %	Thickness mm	Sheet Size mm	Weight kg per sheet
PR0.5T1A	304	0.5	1	23	0.4	2000x1000	5.00
PR0.8T1.5	304	0.8	1.5	25	0.5	2000x1000	6.00
PR0.8T1.5B	316	0.8	1.5	25	0.5	2000x1000	6.00
PR1T2A	304	1	2	23	0.5	2000x1000	6.00
PR1T2B	304	1	2	23	0.75	2000x1000	9.00
PR1T2C	304	1	2	23	1	2000x1000	12.00
PR1.1T2	316	1.1	2	23	0.75	2000x1000	9.00
PR1.5T2.75	304	1.5	2.75	26	1	2000x1000	12.00
PR1.5T2.75B	316	1.5	2.75	26	1	2000x1000	12.00
PR2T3A	304	2	3	40	1	2000x1000	10.00
PR2T3.5A	304	2	3.5	30	1	2000x1000	11.00
PR2T3.5B	304	2	3.5	30	1.5	2000x1000	17.00
PR2T3.5D	316	2	3.5	30	1	2000x1000	11.00
PR3T4A	304	3	4	50	1	2000x1000	8.00
PR3T4B	316	3	4	50	1	2000x1000	8.00
PR3T5A	304	3	5	32	1	2000x1000	11.00
PR3T5B	304	3	5	32	1.5	2000x1000	16.00
PR3T5C	316	3	5	32	1	2000x1000	11.00
PR3T5D	304	3	5	32	2	2000x1000	22.00
PR3T5F	316	3	5	32	1.5	2000x1000	16.00
PR3T5G	304	3	5	32	1	2500x1250	17.00
PR3T5H	304	3	5	32	1.5	2500x1250	25.00
PR3T5J	316	3	5	32	2	2000x1000	22.00
PR4T5A	304	4	5	58	1	2000x1000	7.00
PR4T6	304	4	6	40	1	2000x1000	10.00
PR4T7A	304	4	7	29	1.5	2000x1000	17.00
PR4T7B	304	4	7	29	2	2000x1000	23.00

## Metal Mesh - Perforated Metal Round Holes - Stainless Steel

### Product Range overview - Continued

Part-Number	Material Grade	Hole size mm	Pitch mm	Open Area %	Thickness mm	Sheet Size mm	Weight kg per sheet
PR4T7C	316	4	7	29	1.5	2000x1000	17.00
PR4T7D	316	4	7	29	2	2000x1000	23.00
PR5T6A	304	5	6	63	1	2000x1000	6.00
PR5T6B	304	5	6	63	1.5	2000x1000	9.00
PR5T7A	304	5	7	45	0.5	2000x1000	5.00
PR5T7B	304	5	7	45	1	2000x1000	9.00
PR5T7C	316	5	7	45	1	2000x1000	9.00
PR5T8A	304	5	8	35	1.5	2000x1000	15.00
PR5T8B	304	5	8	35	2	2000x1000	21.00
PR5T8C	316	5	8	35	1.5	2000x1000	15.00
PR5T8D	304	5	8	35	1	2500x1250	16.00
PR5T8E	304	5	8	35	1.5	2500x1250	24.00
PR5T10	304	5	10	23	3	2000x1000	37.00
PR6T8.5B	304	6	8.5	45	1	2000x1000	9.00
PR6T9A	304	6	9	40	1	2000x1000	10.00
PR6T9C	304	6	9	40	1.5	2000x1000	14.00
PR6T9B	304	6	9	40	2	2000x1000	19.00
PR6T12A	304	6	12	23	3	2000x1000	37.00
PR8T11A	304	8	11	47	1	2000x1000	8.00
PR8T11B	316	8	11	47	1	2000x1000	8.00
PR8T11C	316	8	11	47	1.5	2000x1000	13.00
PR8T12A	304	8	12	40	1.5	2000x1000	14.00
PR8T12B	304	8	12	40	2	2000x1000	19.00
PR8T12C	304	8	12	40	3	2000x1000	29.00
PR10T13	304	10	13	53	1	2000x1000	7.00
PR10T13B	304	10	13	53	1	2500x1250	12.00
PR10T15A	304	10	15	40	1.5	2000x1000	14.00
PR10T15B	304	10	15	40	2	2000x1000	19.00
PR10T15C	304	10	15	40	3	2000x1000	29.00
PR10T15D	316	10	15	40	1.5	2000x1000	14.00
PR10T15E	304	10	15	40	1.5	2500x1250	22.00
PR12T17A	304	12	17	45	1.5	2000x1000	13.00
PR15T20A	304	15	20	50	1	2000x1000	8.00
PR15T21A	304	15	21	46	1.5	2000x1000	13.00
PR15T21B	304	15	21	46	3	2000x1000	26.00

# Metal Mesh - Perforated Metal

## Round Holes - Mild Steel

### Overview

- Made in Europe - Premium Quality
- Mild Steel
- Sheet sizes 1000x2000 or 1250x2500mm
- Burr free, flat sheets

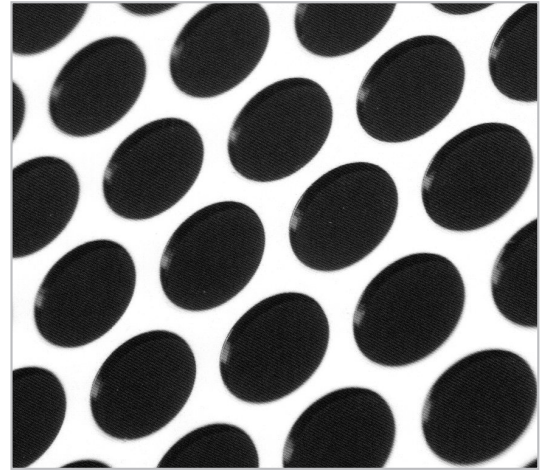

### Product Range overview

Part-Number	Material Grade	Hole size mm	Pitch mm	Open Area %	Thickness mm	Sheet Size mm	Weight kg per sheet
PR0.5T1M	MS	0.5	1	23	0.4	2000x1000	5.00
PR0.8T1.5M	MS	0.8	1.5	25	0.5	2000x1000	6.00
PR1T2M	MS	1	2	23	0.7	2000x1000	9.00
PR1T2O	MS	1	2	23	1	2000x1000	12.00
PR1.2T2.25N	MS	1.2	2.25	25	1	2000x1000	12.00
PR1.5T2.75P	MS	1.5	2.75	26	1.5	2000x1000	18.00
PR2T3M	MS	2	3	40	1	2000x1000	10.00
PR2T3N	MS	2	3	40	2	2500x1250	30.00
PR2.5T3.5M	MS	2.5	3.5	46	1	2000x1000	9.00
PR2.5T3.5N	MS	2.5	3.5	46	2	2500x1250	27.00
PR2.5T4	MS	2.5	4	35	1	2000x1000	10.00
PR2.5T4.5M	MS	2.5	4.5	28	1	2000x1000	11.00
PR2.5T4.5N	MS	2.5	4.5	28	1.5	2000x1000	17.00
PR2.5T5N	MS	2.5	5	23	2.5	2000x1000	17.00
PR3T4N	MS	3	4	50	1	2000x1000	8.00
PR3T4P	MS	3	4	50	2	2500x1250	25.00
PR3T4Q	MS	3	4	50	2.5	2000x1000	20.00
PR3T5S	MS	3	5	32	3	2000x1000	32.00



## Metal Mesh - Perforated Metal Round Holes - Mild Steel

---

### Product Range overview - Continued

Part-Number	Material Grade	Hole size mm	Pitch mm	Open Area %	Thickness mm	Sheet Size mm	Weight kg per sheet
PR3T5W	MS	3	5	32	2	2500x1250	34.00
PR4T5N	MS	4	5	58	1	2000x1000	7.00
PR4T6N	MS	4	6	40	0.7	2000x1000	7.00
PR4T6P	MS	4	6	40	1.5	2000x1000	14.00
PR4T6R	MS	4	6	40	2.5	2000x1000	24.00
PR4T6S	MS	4	6	40	3	2500x1250	45.00
PR4T7N	MS	4	7	29	3	2000x1000	34.00
PR5T6	MS	5	6	63	1	2000x1000	6.00
PR5T7O	MS	5	7	45	2	2000x1000	17.00
PR5T7P	MS	5	7	45	1	2000x1000	9.00
PR5T7Q	MS	5	7	45	1.5	2000x1000	13.00
PR5T7V	MS	5	7	45	1	2500x1250	14.00
PR5T7Z	MS	5	7	45	1.5	2500x1250	20.00
PR5T8N	MS	5	8	35	3	2000x1000	31.00
PR6T8.5P	MS	6	8.5	45	1.5	2000x1000	13.00
PR6T8.5S	MS	6	8.5	45	1.5	2500x1250	20.00
PR6T9M	MS	6	9	40	3	2000x1000	29.00
PR8T11N	MS	8	11	47	1.5	2000x1000	13.00
PR8T11S	MS	8	11	47	1.5	2500x1250	20.00
PR8T11T	MS	8	11	47	2	2000x1000	17.00

# Metal Mesh - Perforated Metal

## Round Holes - Mild Steel

---

### Product Range overview - Continued

Part-Number	Material Grade	Hole size mm	Pitch mm	Open Area %	Thickness mm	Sheet Size mm	Weight kg per sheet
PR8T12N	MS	8	12	40	3	2000x1000	29.00
PR10T13M	MS	10	13	53	1	2000x1000	7.00
PR10T13N	MS	10	13	53	1.5	2000x1000	11.00
PR10T15N	MS	10	15	40	3	2000x1000	29.00
PR10T15S	MS	10	15	40	1.5	2500x1250	22.00
PR10T15T	MS	10	15	40	2	2500x1250	30.00
PR12T13	MS	12	13	77	1	2000x1000	4.00
PR12T16	MS	12	16	51	1	2000x1000	8.00
PR12T17M	MS	12	17	45	2	2000x1000	18.00
PR15T20R	MS	15	20	50	1.5	2000x1000	12.00
PR20T25M	MS	20	25	58	1	2000x1000	7.00
PR20T27M	MS	20	27	51	2	2000x1000	16.00
PR20T27N	MS	20	27	51	3	2000x1000	24.00

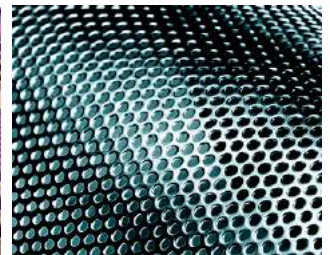
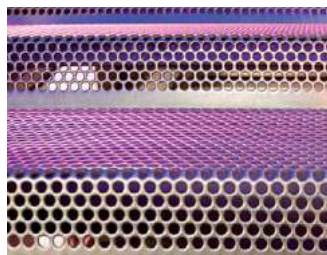

# Metal Mesh - Perforated Metal Round Holes - Galvanised Steel

## Overview

- Made in Europe - Premium Quality
- Galvanised Mild Steel
- Sheet sizes 1000x2000 or 1250x2500mm
- Burr free, flat sheets

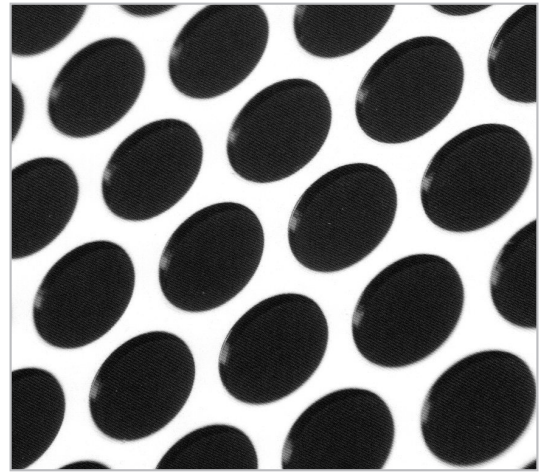

## Product Range overview

Part-Number	Material Grade	Hole size mm	Pitch mm	Open Area %	Thickness mm	Sheet Size mm	Weight kg per sheet
PR2T3.5Q	GAL	2	3.5	30	1	2000x1000	11.00
PR3T5T	GAL	3	5	32	1	2000x1000	11.00
PR3T5X	GAL	3	5	32	1.5	2500x1250	26.00
PR5T7S	GAL	5	7	45	1	2000x1000	9.00
PR5T7W	GAL	5	7	45	0.8	2500x1250	11.00
PR5T7X	GAL	5	7	45	1	2500x1250	14.00
PR5T7Y	GAL	5	7	45	1.5	2500x1250	21.00
PR5T8T	GAL	5	8	35	2	2500x1250	33.00
PR8T11Q	GAL	8	11	47	1.5	2000x1000	13.00
PR8T11R	GAL	8	11	47	1.5	2500x1250	20.00
PR8T12Q	GAL	8	12	40	2	2500x1250	30.00
PR10T13Q	GAL	10	13	53	1	2000x1000	8.00
PR10T13R	GAL	10	13	53	1.5	2000x1000	11.00
PR10T13S	GAL	10	13	53	1.5	2500x1250	18.00
PR15T20P	GAL	15	20	50	1.5	2000x1000	12.00
PR20T27P	GAL	20	27	51	2	2500x1250	25.00

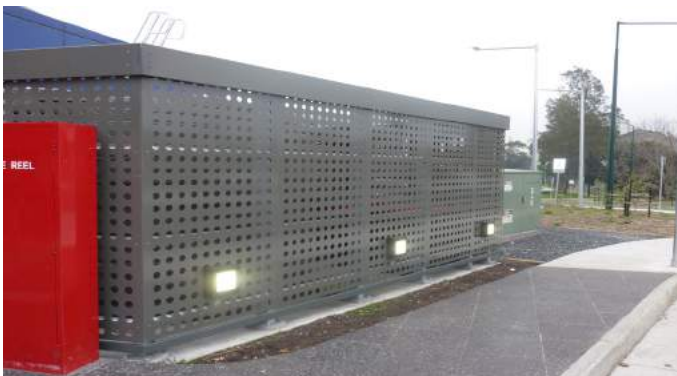

# Metal Mesh - Perforated Metal Round Holes - Aluminium

## Overview

- Made in Europe - Premium Quality
- Aluminium
- Sheet sizes 2000x1000 or 2500x1250mm
- Burr free, flat sheets

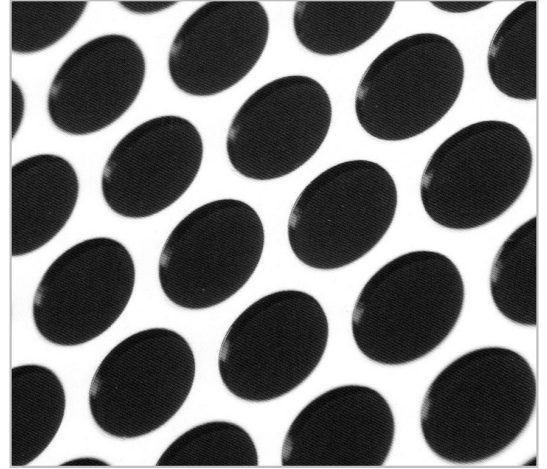

## Product Range overview

Part-Number	Material Grade	Hole size mm	Pitch mm	Open Area %	Thickness mm	Sheet Size mm	Weight kg per sheet
PR2T3.5T	ALU	2	3.5	30	1	2000x1000	4.00
PR3T5MA	ALU	3	5	32	1	2000x1000	4.00
PR3T6P	ALU	3	6	23	1.5	2000x1000	6.00
PR4T8X	ALU	4	8	23	1.5	2000x1000	6.00
PR5T7U	ALU	5	7	45	1.5	2000x1000	5.00
PR10T15Q	ALU	10	15	40	2	2000x1000	7.00
PR10T15R	ALU	10	15	40	2	2500x1250	10.00
PR15T20Q	ALU	15	20	50	3	2000x1000	8.00

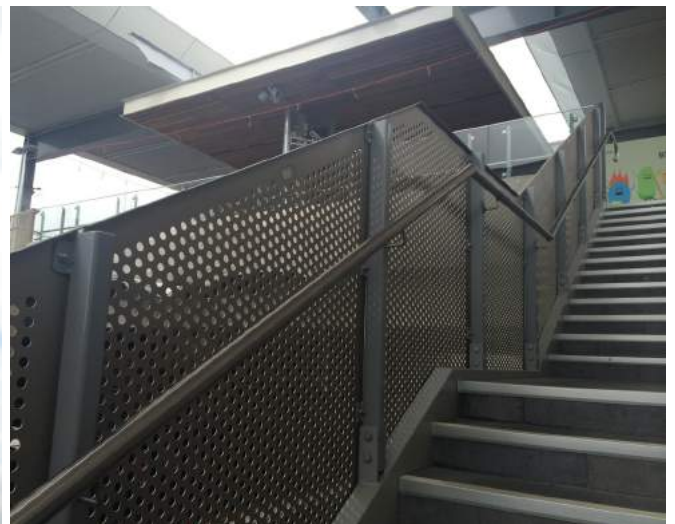
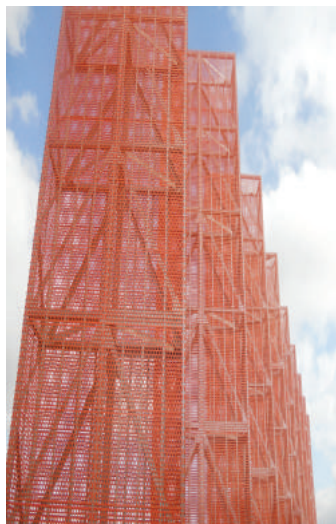

# Metal Mesh - Perforated Metal

## Square Holes - Illustration of Perforation

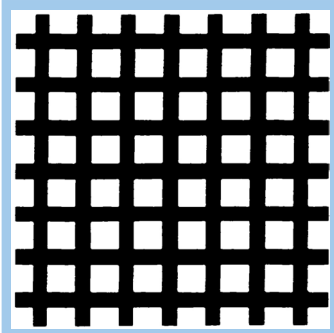

C3.5 U5.5 40% - 3.5mm hole

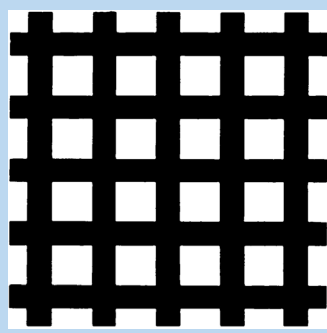

C5 U8 39% - 5mm hole

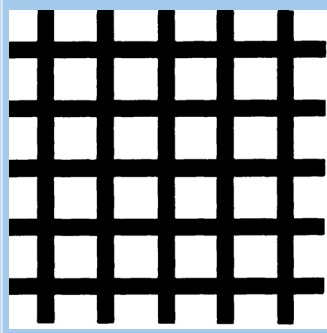

C5.5 U7.5 54% - 5.5mm hole

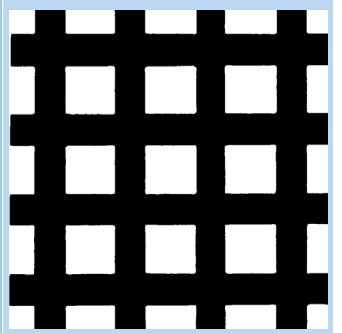

C6 U10 36% - 6mm hole

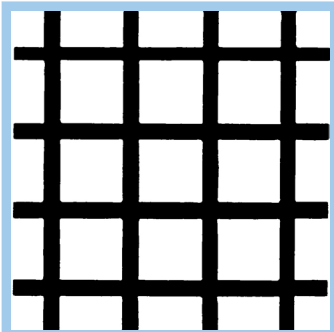

C8 U10 64% - 8mm hole

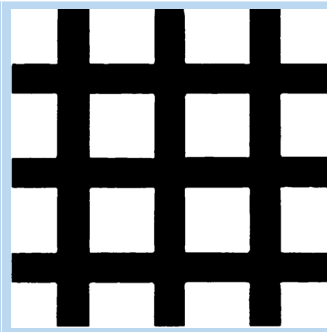

C8 U12 44% - 8mm hole

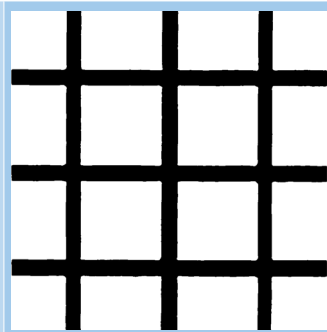

C10 U12 70% - 10mm hole

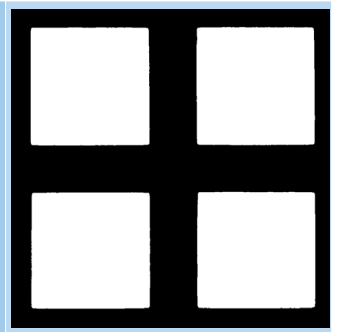

C15 U21 51% 15mm hole

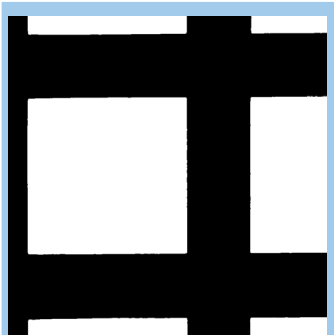

C20 U28 51% - 20mm hole



# Metal Mesh - Perforated Metal

## Square Holes - All material grades

### Overview

- Made in Europe - Premium Quality
- Stainless Steel (304), Aluminium (ALU), Mild Steel (MS) or Galvanised (GAL)
- Sheet sizes 2000x1000 or 2500x1250mm
- Burr free, flat sheets

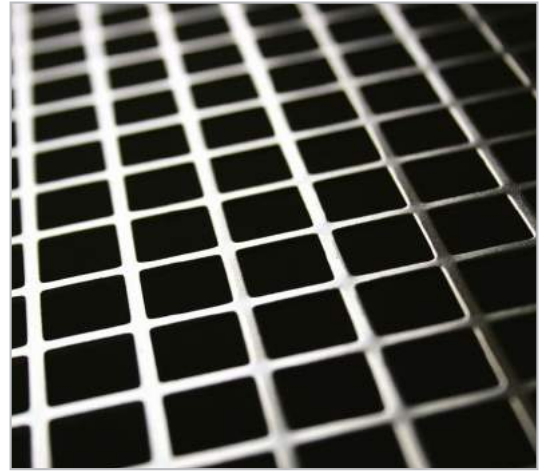

### Product Range overview

Part-Number	Material Grade	Hole size mm	Pitch mm	Open Area %	Thickness mm	Sheet Size mm	Weight kg per sheet
PC3.5U5.5M	MS	3.5	5.5	40	1	2000x1000	10.00
PC5.5U8	GAL	5.5	8	47	1.5	2500x1250	20.00
PC5U8B	304	5	8	39	1.5	2000x1000	15.00
PC5U8W	ALU	5	8	39	1	2000x1000	4.00
PC8U10	MS	8	10	64	1	2000x1000	6.00
PC8U12B	304	8	12	44	1.5	2000x1000	13.00
PC8U12N	MS	8	12	44	1.5	2000x1000	13.00
PC10U12A	304	10	12	70	1	2000x1000	5.00
PC10U12B	304	10	12	70	1.5	2000x1000	7.00
PC10U12G	GAL	10	12	70	1.5	2500x1250	11.00
PC10U12M	MS	10	12	70	1.0	2000x1000	5.0
PC10U12N	MS	10	12	70	1.5	2000x1000	7.00
PC10U15	MS	10	15	45	1	2000x1000	9.00
PC10U15A	304	10	15	45	1	2000x1000	9.00
PC10U15B	304	10	15	45	1.5	2000x1000	13.00
PC15U21O	MS	15	21	51	1.5	2500x1250	18.00
PC20U28	MS	20	28	51	2	2000x1000	16.00

Metal Mesh - Perforated Metal  
Round End Slots - Illustration of Perforation

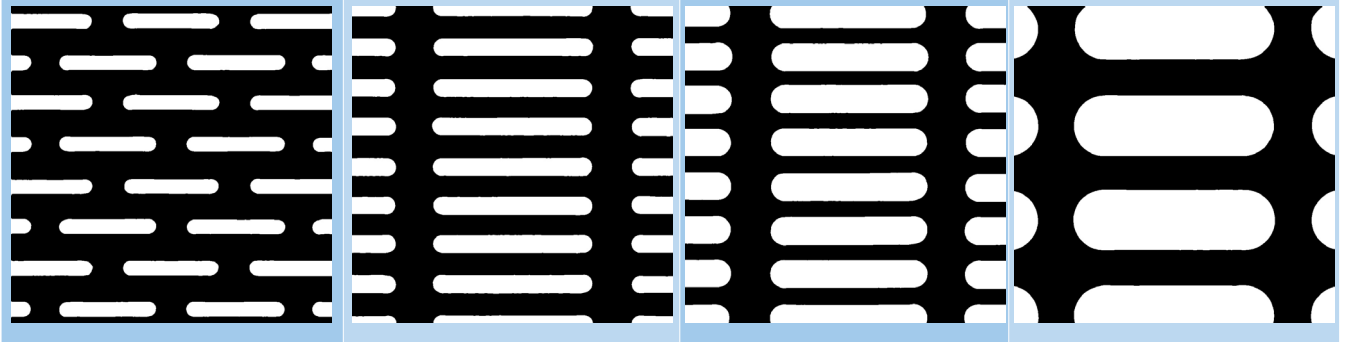

Typical Applications

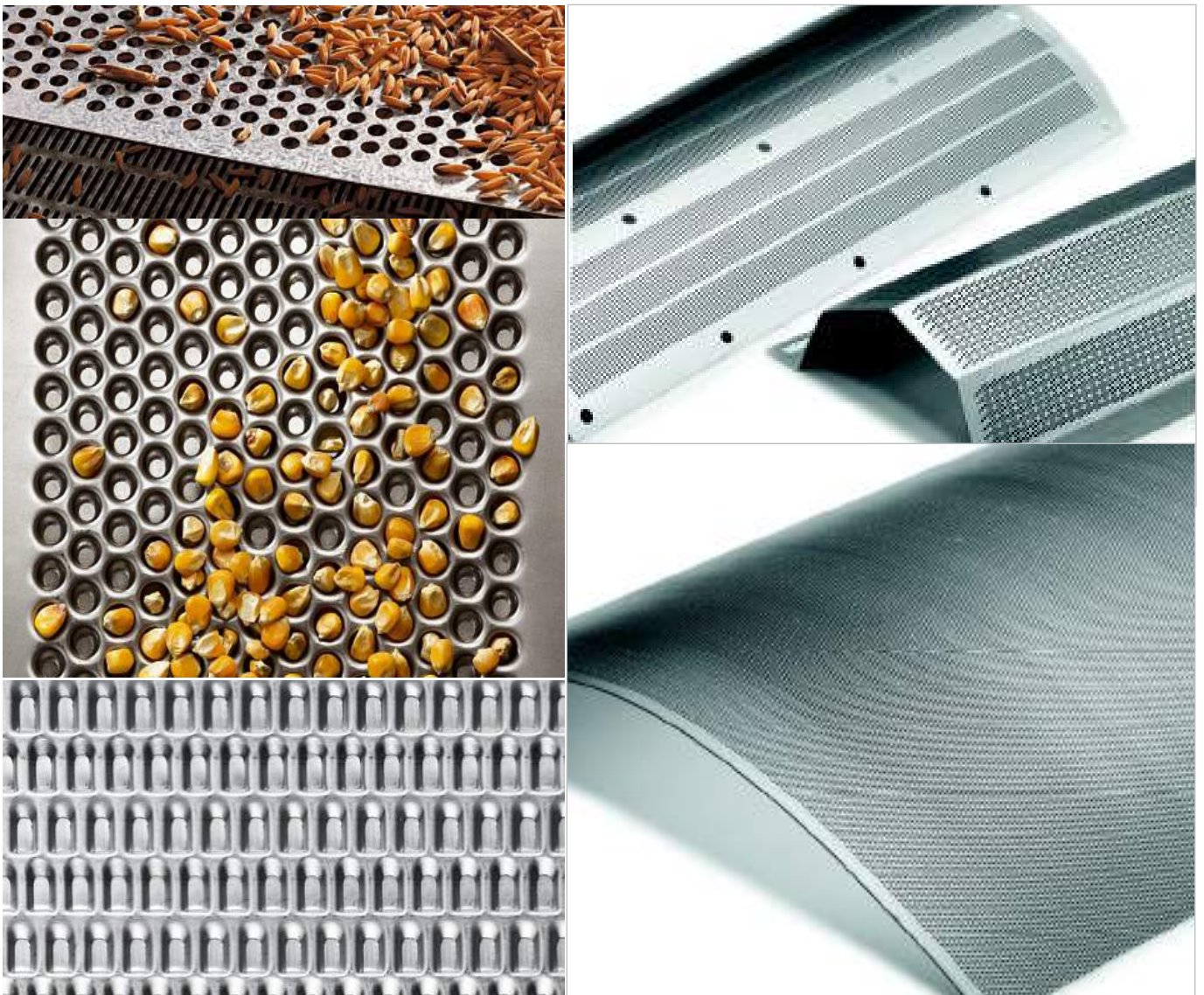

## Metal Mesh - Perforated Metal Round End Slots / Processing Screens

### Overview

- Grain cleaning screens
- Grain drying screens
- Separation and grading screens
- Screens for floor drying
- Screens for silo drying
- Trieur screens
- Rice sorting screens
- Hammer Mill screens
- Malting Floor screens
- Round end slot screens for various applications
- Made in Europe - Premium Quality

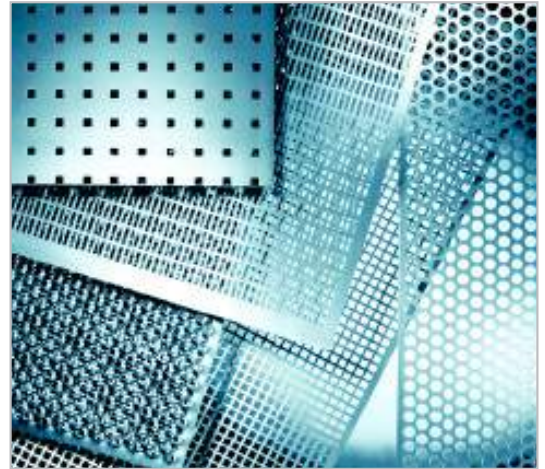

### Product Range overview

We can offer you a specialist range of high quality screens designed to meet today's large volume processing needs in all aspects.

We can offer you both galvanised and stainless steel grain drying screens that deliver optimal airflow and strength. Higher airflow rates give higher drying rates.

Trieur screens are used in specialist machinery to size/sort grain and seeds or separate foreign particles. They are available in mild steel or stainless steel.

Please contact one of our sales specialists to discuss your specific requirements.





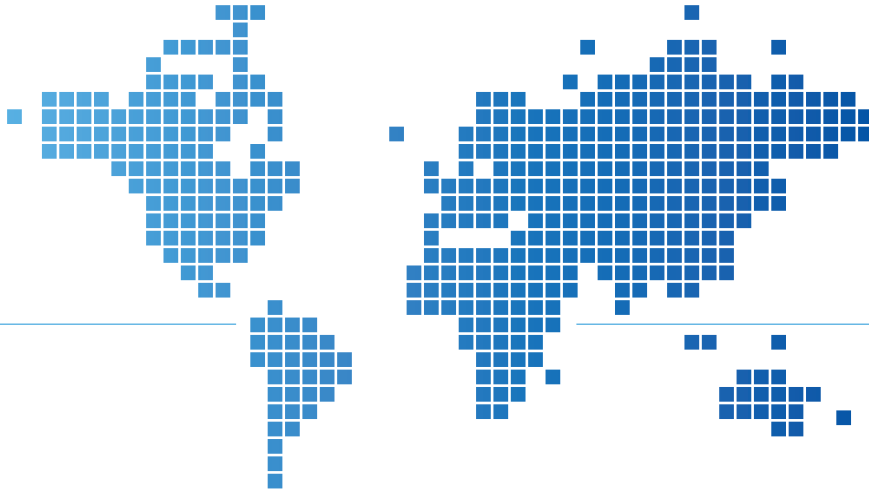

## Sefar worldwide

Sefar is the leading manufacturer of precision fabrics from monofilaments for the screen printing and filtration market. Sefar products are used in a wide variety of industries, reaching from electronics, graphics, medical, automotive, food and pharmaceutical applications to aerospace, mining & refining and architecture. With its profound understanding of the applications Sefar helps its customers to achieve optimum results in their industrial processes. Subsidiaries and fabrications centers in 25 countries on 5 continents provide local technical service for the broad range of solutions offered by Sefar.

Headquarters	Australia & New Zealand			
Switzerland Sefar AG Hinterbissastrasse 12 CH-9410 Heiden	NSW / ACT / VIC / TAS / SA Sefar Pty Ltd 19-21 Huntingwood Drive Huntingwood NSW 2148	QLD / NT Sefar Pty Ltd 6/8 Springlands Drive Slacks Creek Qld 4127	WA Sefar Pty Ltd 2/14 Bally Street Landsdale WA 6065	New Zealand Sefar Ltd 24G Allright Place Mt Wellington, AKL 1060
Ph +41 71 898 57 00 filtration@sefar.com www.sefar.com	Phone +61 1300 306 661 oceanasales@sefar.com www.sefar.com.au	Ph +61 7 3826 0600 salesqld@sefar.com www.sefar.com.au	Ph +61 8 9303 2600 saleswa@sefar.com www.sefar.com.au	Ph +64 9527 4410 salesnz@sefar.com www.sefar.nz

## Product range



### Process Filtration

- Vacuum Belt Filters
- Rotary Drum Filters
- Rotary Disc Filters
- Belt Press Filters
- Filter Press
- Horizontal disc filter
- Leaf Filter
- Tube Press Filter
- Candle Filters
- Batch Filters

### Life Science

- Fluid Bed Dryer bags
- Connector Sleeves
- Bowl screens
- Pharma screens
- Strainer bags
- Centrifuge liners +bags
- Nutsche & dryer bags
- Vent-off dryer bags
- Filter discs

### Food & Beverage

- Nylal Sifter screens
- Dust filter bags
- Centrifuge sifter covers and liners
- Connector sleeves
- Milling accessories
- Belts for food processing

### Liquid Filtration

- Liquid Filter bags
- Filter cartridges
- Filter elements
- Filter vessels
- Self cleaning filters
- Strainers
- Accessories

### Dry Filtration

- FoodTec filter bags for the food industry
- PM-Tec high temp. filter media
- BWF Envirotec dust filter bags
- Ceramic pleated elements

Our most current general sales conditions shall apply.  
Please consult the most current local product data sheet prior to any use.

